

CE Test Report

Product Name : WIRELESS-N NETWORK MINI PCI ADAPTER
Model No. : IWAVEPORT WLM200NX

Applicant : Compex Systems Pte Ltd
Address : 135 Joo Seng Road, #08-01 PM Industrial Building
Singapore 368363

Date of Receipt : 2008/09/10
Issued Date : 2008/10/31
Report No. : 089S061R-RF-CE-P14V03

The test results relate only to the samples tested.

The test results shown in the test report are traceable to the national/international standard through the calibration of the equipment and evaluated measurement uncertainty herein.

This report must not be used to claim product endorsement by CNLA, NVLAP or any agency of the Government.
The test report shall not be reproduced except in full without the written approval of QuieTek Corporation.

Test Report Certification

Issued Date : 2008/10/31

Report No. : 089061R-RF-CE-P14V03



Product Name : WIRELESS-N NETWORK MINI PCI ADAPTER
Applicant : Compex Systems Pte Ltd
Address : 135 Joo Seng Road, #08-01 PM Industrial Building
Singapore 368363
Manufacturer : Compex Systems Pte Ltd
Address : 135 Joo Seng Road, #08-01 PM Industrial Building
Singapore 368363
Model No. : IWAVEPORT WLM200NX
Rated Voltage : AC 230 V / 50 Hz
EUT Voltage : DC 3.3V
Trade Name : COMPEX
Applicable Standard : ETSI EN 302 502 V1.1.1 (2006-11)
Test Result : Complied
Performed Location : SuZhou EMC laboratory
No.99 Hongye Rd., Suzhou Industrial Park Loufeng
Hi-Tech Development Zone., SuZhou, China
TEL: +86-512-6251-5088 / FAX: +86-512-6251-5098

Documented By : 

(Lanny Jin)

Reviewed By : 

(Marlin Chen)

Approved By : 

(Gene Zhang)

Laboratory Information

We , **Quietek Corporation**, are an independent EMC and safety consultancy that was established the whole facility in our laboratories. The test facility has been accredited by the following accreditation Bodies in compliance with ISO 17025, EN 45001 and Guide 25:

Taiwan R.O.C.	: BSMI, DGT, CNLA
Germany	: TUV Rheinland
Norway	: Nemko, DNV
USA	: FCC, NVLAP
Japan	: VCCI

The related certificate for our laboratories about the test site and management system can be downloaded from Quietek Corporation's Web Site : <http://tw.quietek.com/modules/myalbum/>
 The address and introduction of Quietek Corporation's laboratories can be founded in our Web site : <http://www.quietek.com/>
 If you have any comments, Please don't hesitate to contact us. Our contact information is as below:

HsinChu Testing Laboratory :

No.75-2, 3rd Lin, Wangye Keng, Yonghxing Tsuen, Qionglin Shiang, Hsinchu County 307, Taiwan, R.O.C.
 TEL:+886-3-592-8858 / FAX:+886-3-592-8859 E-Mail : service@quietek.com



LinKou Testing Laboratory :

No. 5, Ruei-Shu Valley, Ruei-Ping Tsuen, Lin-Kou Shiang, Taipei, Taiwan, R.O.C.
 TEL : +886-2-8601-3788 / FAX : 886-2-8601-3789 E-Mail : service@quietek.com



Suzhou Testing Laboratory :

No.99 Hongye Rd., Suzhou Industrial Park Loufeng Hi-Tech Development Zone., SuZhou, China
 TEL : +86-512-6251-5088 / FAX : 86-512-6251-5098 E-Mail : service@quietek.com



TABLE OF CONTENTS

Description	Page
1. General Information.....	6
1.1. EUT Description.....	6
1.2. Mode of Operation.....	8
1.3. Tested System Details.....	9
1.4. Configuration of Tested System.....	9
1.5. EUT Exercise Software.....	11
2. Technical Test.....	12
2.1. Summary of Test Result.....	12
2.2. Measurement Uncertainty.....	13
2.3. Test Environment.....	14
3. Frequency Error.....	15
3.1. Test Equipment.....	15
3.2. Test Setup.....	15
3.3. Limit.....	16
3.4. Test Procedure.....	16
3.5. Test Result.....	17
4. Transmitter RF Output Power, EIRP, TPC and EIRP Spectral Density.....	19
4.1. Test Equipment.....	19
4.2. Test Setup.....	19
4.3. Limit.....	20
4.4. Test Procedure.....	20
4.5. Test Result.....	21
5. Transmitter Unwanted Emissions Outside the 5725 MHz to 5875 MHz Band.....	30
5.1. Test Equipment.....	30
5.2. Test Setup.....	31
5.3. Limit.....	32
5.4. Test Procedure.....	32
5.5. Test Result.....	33
5.6. Test Photograph.....	38
6. Transmitter Unwanted Emissions Within the 5725 MHz to 5875 MHz Band.....	39
6.1. Test Equipment.....	39
6.2. Test Setup.....	39
6.3. Limit.....	40
6.4. Test Procedure.....	41
6.5. Test Result.....	42
6.6. Test Photograph.....	57
7. Receiver Spurious Emissions.....	58

7.1.	Test Equipment.....	58
7.2.	Test Setup.....	59
7.3.	Limit....	59
7.4.	Test Procedure	60
7.5.	Test Result.....	61
7.6.	Test Photograph	64
8.	Dynamic Frequency Selection (DFS)	65
8.1.	Test Equipment.....	65
8.2.	Test Setup.....	65
8.3.	Limit....	66
8.4.	Test Procedure	67
8.5.	Test Result.....	67
9.	Attachment	68
➤	EUT Photograph	68

1. General Information

1.1. EUT Description

Product Name	WIRELESS-N NETWORK MINI PCI ADAPTER
Trade Name	COMPEX
Model No.	IWAVEPORT WLM200NX
Working Voltage	DC 3.3V
Frequency Range	For 5.0GHz Band 802.11a/n(20MHz): 5180 - 5320 MHz, 5500 - 5700 MHz, 5745-5825MHz 802.11n(40MHz): 5190 - 5310 MHz, 5510 - 5670 MHz
Channel Number	For 5.0GHz Band 802.11a/n(20MHz): 22 802.11n(40MHz): 9
Type of Modulation	OFDM
Data Rate	802.11a: 6/9/12/18/24/36/48/54 Mbps 802.11n: up to 450 Mbps
Channel Control	Auto
Antenna Type	Omni Antenna
Antenna Gain	2dBi

For 5.0GHz Band

802.11a/n(20MHz) Working Frequency of Each Channel:							
Channel	Frequency	Channel	Frequency	Channel	Frequency	Channel	Frequency
36	5180 MHz	40	5200 MHz	44	5220 MHz	48	5240 MHz
52	5260 MHz	56	5280 MHz	60	5300 MHz	64	5320 MHz
100	5500 MHz	104	5520 MHz	108	5540 MHz	112	5560 MHz
116	5580 MHz	120	5600 MHz	124	5620 MHz	128	5640 MHz
132	5660 MHz	136	5680 MHz	140	5700 MHz	149	5745 MHz
157	5785 MHz	165	5825MHz	N/A	N/A	N/A	N/A

802.11n(40MHz) Working Frequency of Each Channel:							
Channel	Frequency	Channel	Frequency	Channel	Frequency	Channel	Frequency
38	5190 MHz	46	5230 MHz	54	5270 MHz	62	5310 MHz
102	5510 MHz	110	5550 MHz	118	5590 MHz	126	5630 MHz
134	5670 MHz	N/A	N/A	N/A	N/A	N/A	N/A

802.11a/n Antenna List

Antenna	Manufacturer	Model No.	Peak Gain
Combined Antenna	Exceltek Electronics (Kunshan) Co.,Ltd	C0053-ANG0004	2.0 dBi

1.2. Mode of Operation

Quietek has verified the construction and function in typical operation. All the test modes were carried out with the EUT in normal operation, which was shown in this test report and defined as:

Test Mode
Mode 1: Transmit by 802.11a
Mode 2: Transmit by 802.11n (20MHz)
Mode 3: Receive by 802.11n (20MHz)

1.3. Tested System Details

The types for all equipments, plus descriptions of all cables used in the tested system (including inserted cards) are:

Product	Manufacturer	Model No.	Serial No.	Power Cord
1 Router Frame	Compex	B-543W	N/A	N/A
2 Adapter	DVE	DSA-15P-24	N/A	N/A
3 Notebook	DELL	PP19L	JH097 A01	Power by adapter
4 MacBook	Apple	MB061CH	W8732B4TZ5V	Power by adapter

1.4. Configuration of Tested System

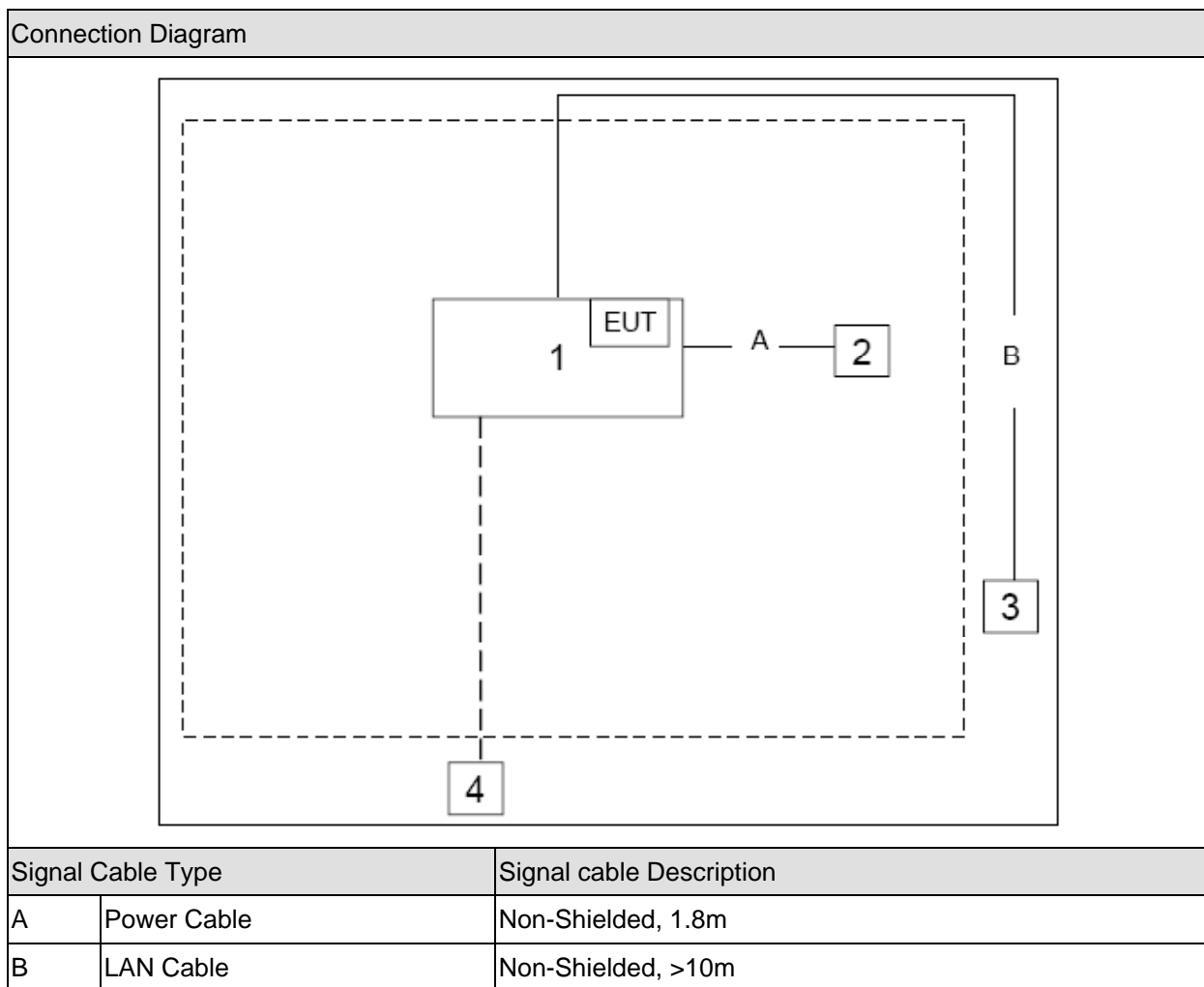

1.5. EUT Exercise Software

1	Setup the EUT and simulators as shown on above.
2	Turn on the power of equipment.
3	Execute the "brinks" software, then select test mode and test channel, press OK to transmit data with another Notebook P.C. by wireless.

2. Technical Test

2.1. Summary of Test Result

- No deviations from the test standards
 Deviations from the test standards as below description:

Performed Test Item	Normative References	Test Performed	Deviation
Frequency Error	ETSI EN 302 502 V1.1.1 (2006-11)	Yes	No
Transmitter RF Output Power, EIRP, TPC and EIRP Spectral Density	ETSI EN 302 502 V1.1.1 (2006-11)	Yes	No
Transmitter Unwanted Emissions Outside the 5725 MHz to 5875 MHz Band	ETSI EN 302 502 V1.1.1 (2006-11)	Yes	No
Transmitter Unwanted Emissions Within the 5725 MHz to 5875 MHz Band	ETSI EN 302 502 V1.1.1 (2006-11)	Yes	No
Receiver Spurious Emissions	ETSI EN 302 502 V1.1.1 (2006-11)	Yes	No
Dynamic Frequency Selection (DFS)	ETSI EN 302 502 V1.1.1 (2006-11)	Yes	No

2.2. Measurement Uncertainty

Where relevant, the following measurement uncertainty levels have been estimated for tests performed on the apparatus:

Parameter	Uncertainty
Radio Frequency	$\pm 1 \times 10^{-7}$
RF Power Conducted	$\pm 0.7\text{dB}$
RF Power Radiated	$\pm 5.2\text{dB}$
Spurious Emissions, Conducted	$\pm 2.8\text{dB}$
Spurious Emissions, Radiated	$\pm 5.2\text{dB}$
Temperature	$\pm 0.5^{\circ}\text{C}$
Humidity	$\pm 1\%$
Time	$\pm 8\%$

2.3. Test Environment

Items	Required (IEC 68-1)	Actual
Temperature (°C)	15-35	24
Humidity (%RH)	25-75	48
Barometric pressure (mbar)	860-1060	950-1000

3. Frequency Error

3.1. Test Equipment

Frequency Error / AC-4

Instrument	Manufacturer	Type No.	Serial No.	Cal. Date
Spectrum Analyzer	Agilent	E4446A	MY45300103	2008/06/11
Preamplifier	QuieTek	AP-180C	CHM-0602013	2007/11/25
Broad-Band Horn Antenna	Schwarzbeck	BBHA9120D	496	2008/10/28
Coaxial Cable	Huber+Suhner	AC4-RH	07	2007/11/25
Coaxial Cable	Huber+Suhner	AC4-RF	09	2007/11/25
Temperature/Humidity Meter	zhicheng	ZC1-2	QT-TH007	2008/03/09

Note: All equipments are calibrated with traceable calibrations. Each calibration is traceable to the national or international standards.

3.2. Test Setup

For Conducted Measurement

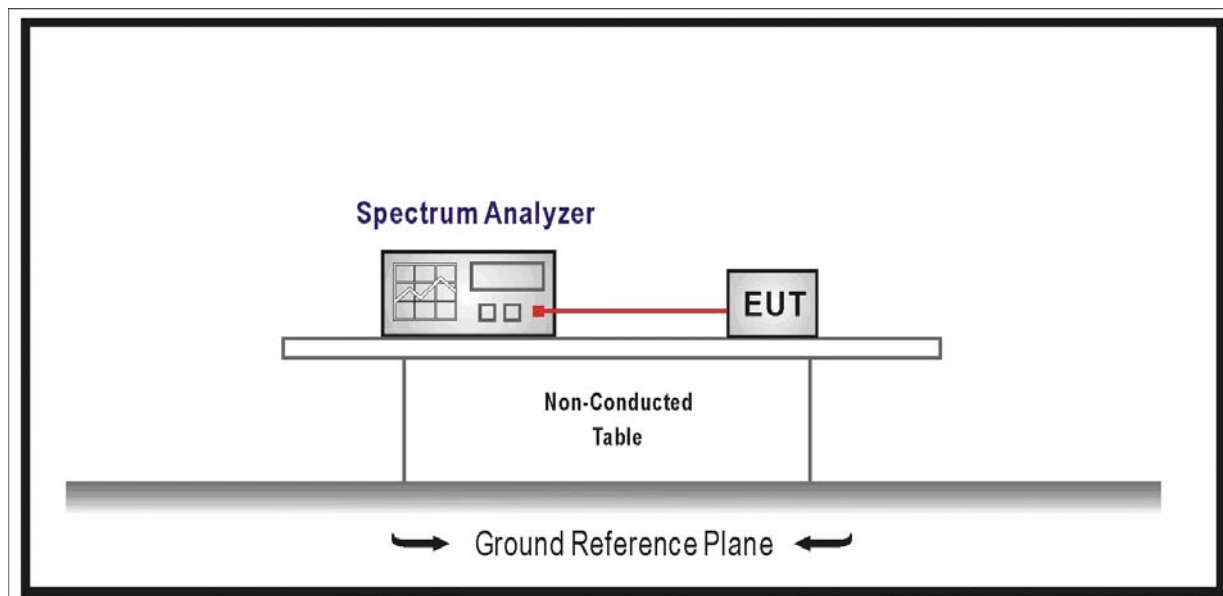

For Radiated Measurement

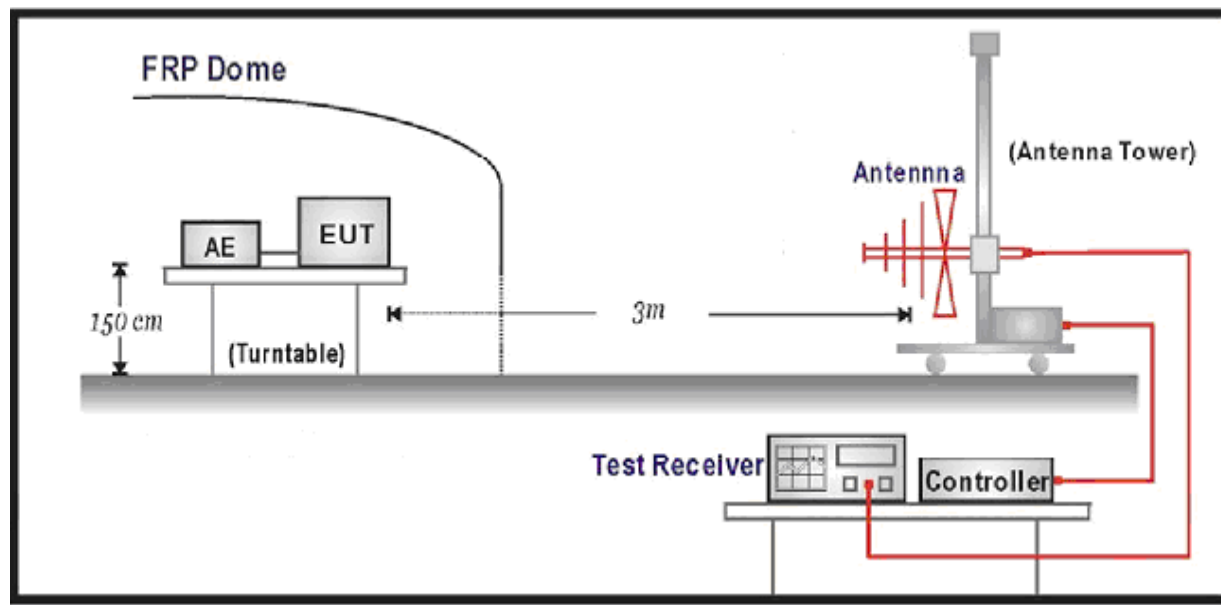

3.3. Limit

The manufacturer shall declare the centre frequencies on which the equipment can operate. The equipment shall only operate in channels centred on any of those frequencies identified in clause 4.1.1 of standard.

The actual carrier centre frequency shall be maintained within the range $f_c \pm 20$ ppm of the nominal channel centre frequency.

3.4. Test Procedure

Refer to ETSI EN 302 502 V1.1.1 (2006-11) Clause 5.3.2

3.5. Test Result

Product	:	WIRELESS-N NETWORK MINI PCI ADAPTER
Test Item	:	Frequency Error
Test Site	:	AC-4
Test Mode	:	Mode 1: Transmit by 802.11a – chain 010

Test Conditions		Test Frequency (MHz)	Measurement Frequency (MHz)	ΔF (ppm)	Limit (ppm)
Tnom (25 °C)	Vnom (AC 230V)	5745.000000	5744.987657	-2.15	±20
		5825.000000	5824.983584	-2.82	±20
Tmax (40 °C)	Vmax (AC 253V)	5745.000000	5744.978464	-3.75	±20
		5825.000000	5824.978687	-3.66	±20
Tmax (40 °C)	Vmin (AC 207V)	5745.000000	5744.978375	-3.76	±20
		5825.000000	5824.978564	-3.68	±20
Tmin (0 °C)	Vmax (AC 253V)	5745.000000	5744.977488	-3.92	±20
		5825.000000	5824.978004	-3.78	±20
Tmin (0 °C)	Vmin (AC 207V)	5745.000000	5744.977694	-3.88	±20
		5825.000000	5824.978012	-3.77	±20

Product	:	WIRELESS-N NETWORK MINI PCI ADAPTER
Test Item	:	Frequency Error
Test Site	:	AC-4
Test Mode	:	Mode 1: Transmit by 802.11a – chain 100

Test Conditions		Test Frequency (MHz)	Measurement Frequency (MHz)	ΔF (ppm)	Limit (ppm)
Tnom (25 °C)	Vnom (AC 230V)	5745.000000	5744.986388	-2.37	±20
		5825.000000	5824.982743	-2.96	±20
Tmax (40 °C)	Vmax (AC 253V)	5745.000000	5744.977436	-3.93	±20
		5825.000000	5824.968853	-5.35	±20
Tmax (40 °C)	Vmin (AC 207V)	5745.000000	5744.976948	-4.01	±20
		5825.000000	5824.968965	-5.33	±20
Tmin (0 °C)	Vmax (AC 253V)	5745.000000	5744.976135	-4.15	±20
		5825.000000	5824.966743	-5.71	±20
Tmin (0 °C)	Vmin (AC 207V)	5745.000000	5744.976793	-4.04	±20
		5825.000000	5824.967492	-5.58	±20

4. Transmitter RF Output Power, EIRP, TPC and EIRP Spectral Density

4.1. Test Equipment

Transmitter RF Output Power, EIRP, TPC and EIRP Spectral Density / AC-4

Instrument	Manufacturer	Type No.	Serial No.	Cal. Date
Spectrum Analyzer	Agilent	E4446A	MY45300103	2008/06/11
PSG Analog S.G.	Agilent	E8257D	MY44321116	2008/06/11
Power Meter	Agilent	E4416A	GB41293844	2008/10/21
Power Sensor	Agilent	E9323A	MY44420302	2008/10/21
Preamplifier	Quietek	AP-180C	CHM-0602013	2007/11/25
Broad-Band Horn Antenna	Schwarzbeck	BBHA9120D	496	2008/06/28
Broad-Band Horn Antenna	Schwarzbeck	BBHA9120D	499	2008/06/28
Coaxial Cable	Huber+Suhner	AC4-RH	07	2007/11/25
Coaxial Cable	Huber+Suhner	AC4-T	08	2007/11/25
Coaxial Cable	Huber+Suhner	AC4-RF	09	2007/11/25
Temperature/Humidity Meter	zhicheng	ZC1-2	QT-TH007	2008/03/09

Note: All equipments are calibrated with traceable calibrations. Each calibration is traceable to the national or international standards.

4.2. Test Setup

For Conducted Measurement

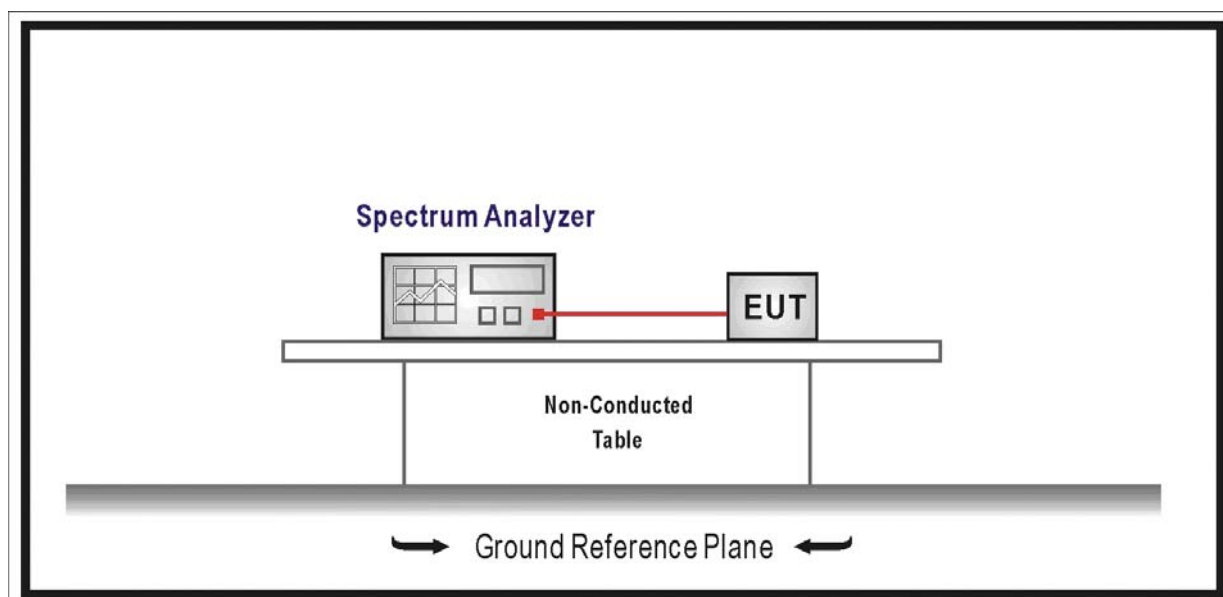

For Radiated Measurement

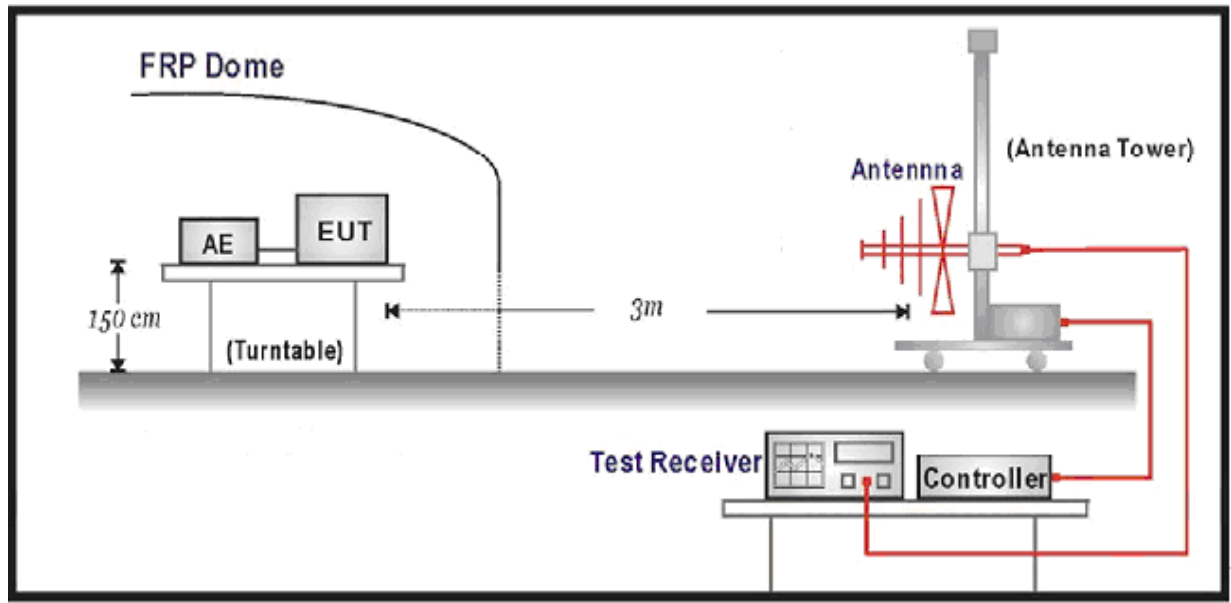

4.3. Limit

The mean EIRP, RF power and EIRP spectral density when configured to operate at the highest stated power level (P_{cond_1}) shall not exceed the limit in following table.

Mean RF output power, EIRP and power density limits at the highest power level			
Channel Width ChS	Mean RF power into antenna (dBm)	Mean EIRP (dBm)	Mean EIRP spectral density (dBm/MHz)
10 MHz	27	33	23
20 MHz	30	36	23

The FWA device shall have the capability to reduce the operating mean EIRP level to level not exceeding 24 dBm for ChS = 20 MHz and 21 dBm for ChS = 10 MHz.

Note: The mean EIRP and the mean EIRP spectral density limits apply to a device and not to each radio of a device.

4.4. Test Procedure

Refer to ETSI EN 302 502 V1.1.1 (2006-11) Clause 5.3.3

4.5. Test Result

Product	:	WIRELESS-N NETWORK MINI PCI ADAPTER
Test Item	:	Transmitter RF Output Power
Test Site	:	AC-4
Test Mode	:	Mode 1: Transmit by 802.11a – chain 010

Antenna Gain = 2dBi, Duty Cycle = 99 %							
Test Conditions		Frequency (MHz)	Reading Level (dBm)	RF Power into Antenna (dBm)	Cableloss (dB)	EIRP Level (dBm)	Limit (dBm)
Tnom (25°C)	Vnom (AC 230V)	5745	15.76	30	1.3	19.10	36
		5825	16.06	30	1.3	19.40	36
Tmax (40°C)	Vmax (AC 253V)	5745	14.64	30	1.3	17.98	36
		5825	15.00	30	1.3	18.34	36
Tmax (40°C)	Vmin (AC 207V)	5745	14.62	30	1.3	17.96	36
		5825	15.00	30	1.3	18.34	36
Tmin (0 °C)	Vmax (AC 253V)	5745	16.84	30	1.3	20.18	36
		5825	17.18	30	1.3	20.52	36
Tmin (0 °C)	Vmin (AC 207V)	5745	16.84	30	1.3	20.18	36
		5825	17.18	30	1.3	20.52	36

RF Power = Measured Power + Test Cable Loss + 10 log (1/Duty Cycle)

EIRP = RF Power + Antenna Gain

Product	:	WIRELESS-N NETWORK MINI PCI ADAPTER
Test Item	:	Transmitter RF Output Power
Test Site	:	AC-4
Test Mode	:	Mode 2: Transmit by 802.11n(20MHz) – chain 010

Antenna Gain = 2dBi, Duty Cycle = 99 %							
Test Conditions		Frequency (MHz)	Reading Level (dBm)	RF Power into Antenna (dBm)	Cableloss (dB)	EIRP Level (dBm)	Limit (dBm)
Tnom (25°C)	Vnom (AC 230V)	5745	14.76	30	1.3	18.10	36
		5825	14.96	30	1.3	18.30	36
Tmax (40°C)	Vmax (AC 253V)	5745	13.48	30	1.3	16.82	36
		5825	13.85	30	1.3	17.19	36
Tmax (40°C)	Vmin (AC 207V)	5745	13.48	30	1.3	16.82	36
		5825	13.86	30	1.3	17.20	36
Tmin (0 °C)	Vmax (AC 253V)	5745	15.84	30	1.3	19.18	36
		5825	16.05	30	1.3	19.39	36
Tmin (0 °C)	Vmin (AC 207V)	5745	15.83	30	1.3	19.17	36
		5825	16.05	30	1.3	19.39	36

RF Power = Measured Power + Test Cable Loss + 10 log (1/Duty Cycle)

EIRP = RF Power + Antenna Gain

Product	:	WIRELESS-N NETWORK MINI PCI ADAPTER
Test Item	:	Transmitter RF Output Power
Test Site	:	AC-4
Test Mode	:	Mode 1: Transmit by 802.11a – chain 100

Antenna Gain = 2dBi, Duty Cycle = 99 %							
Test Conditions		Frequency (MHz)	Reading Level (dBm)	RF Power into Antenna (dBm)	Cableloss (dB)	EIRP Level (dBm)	Limit (dBm)
Tnom (25°C)	Vnom (AC 230V)	5745	5745	10.34	1.3	13.68	24
		5825	5825	10.71	1.3	14.05	24
Tmax (40°C)	Vmax (AC 253V)	5745	5745	9.26	1.3	12.60	24
		5825	5825	9.53	1.3	12.87	24
Tmax (40°C)	Vmin (AC 207V)	5745	5745	9.25	1.3	12.59	24
		5825	5825	9.53	1.3	12.87	24
Tmin (0 °C)	Vmax (AC 253V)	5745	5745	11.52	1.3	14.86	24
		5825	5825	11.85	1.3	15.19	24
Tmin (0 °C)	Vmin (AC 207V)	5745	5745	11.53	1.3	14.87	24
		5825	5825	11.85	1.3	15.19	24

RF Power = Measured Power + Test Cable Loss + 10 log (1/Duty Cycle)

EIRP = RF Power + Antenna Gain

Product	:	WIRELESS-N NETWORK MINI PCI ADAPTER
Test Item	:	Transmitter RF Output Power
Test Site	:	AC-4
Test Mode	:	Mode 2: Transmit by 802.11n(20MHz) – chain 100

Antenna Gain = 2dBi, Duty Cycle = 99 %							
Test Conditions		Frequency (MHz)	Reading Level (dBm)	RF Power into Antenna (dBm)	Cableloss (dB)	EIRP Level (dBm)	Limit (dBm)
Tnom (25°C)	Vnom (AC 230V)	5745	10.34	1.3	13.68	24	10.34
		5825	10.71	1.3	14.05	24	10.71
Tmax (40°C)	Vmax (AC 253V)	5745	9.27	1.3	12.61	24	9.27
		5825	9.55	1.3	12.89	24	9.55
Tmax (40°C)	Vmin (AC 207V)	5745	9.26	1.3	12.60	24	9.26
		5825	9.54	1.3	12.88	24	9.54
Tmin (0 °C)	Vmax (AC 253V)	5745	11.52	1.3	14.86	24	11.52
		5825	11.92	1.3	15.26	24	11.92
Tmin (0 °C)	Vmin (AC 207V)	5745	11.52	1.3	14.86	24	11.52
		5825	11.93	1.3	15.27	24	11.93

RF Power = Measured Power + Test Cable Loss + 10 log (1/Duty Cycle)

EIRP = RF Power + Antenna Gain

Product	:	WIRELESS-N NETWORK MINI PCI ADAPTER
Test Item	:	Transmitter Power Control (TPC)
Test Site	:	AC-4
Test Mode	:	Mode 1: Transmit by 802.11a – chain 010

Test Conditions		Frequency (MHz)	Measured Power (dBm)	Test Cable Loss (dB)	EIRP of TPC (dBm)	Limit (dBm)
Tnom (25°C)	Vnom (AC 230V)	5745	10.67	1.3	14.01	24
		5825	10.68	1.3	14.02	24
Tmax (40°C)	Vmax (AC 253V)	5745	9.57	1.3	12.91	24
		5825	9.59	1.3	12.93	24
Tmax (40°C)	Vmin (AC 207V)	5745	9.57	1.3	12.91	24
		5825	9.60	1.3	12.94	24
Tmin (0°C)	Vmax (AC 253V)	5745	11.74	1.3	15.08	24
		5825	11.80	1.3	15.14	24
Tmin (0°C)	Vmin (AC 207V)	5745	11.74	1.3	15.08	24
		5825	11.79	1.3	15.13	24

EIRP of TPC = Measured Power + Antenna Gain + Test Cable Loss + 10 log (1/Duty Cycle)

Product	:	WIRELESS-N NETWORK MINI PCI ADAPTER
Test Item	:	Transmitter Power Control (TPC)
Test Site	:	AC-4
Test Mode	:	Mode 2: Transmit by 802.11n(20MHz) – chain 010

Test Conditions		Frequency (MHz)	Measured Power (dBm)	Test Cable Loss (dB)	EIRP of TPC (dBm)	Limit (dBm)
Tnom (25°C)	Vnom (AC 230V)	5745	10.58	1.3	13.92	24
		5825	10.62	1.3	13.96	24
Tmax (40°C)	Vmax (AC 253V)	5745	9.42	1.3	12.76	24
		5825	9.58	1.3	12.92	24
Tmax (40°C)	Vmin (AC 207V)	5745	9.42	1.3	12.76	24
		5825	9.58	1.3	12.92	24
Tmin (0°C)	Vmax (AC 253V)	5745	11.63	1.3	14.97	24
		5825	11.80	1.3	15.14	24
Tmin (0°C)	Vmin (AC 207V)	5745	11.63	1.3	14.97	24
		5825	11.79	1.3	15.13	24

EIRP of TPC = Measured Power + Antenna Gain + Test Cable Loss + 10 log (1/Duty Cycle)

Product	:	WIRELESS-N NETWORK MINI PCI ADAPTER
Test Item	:	Transmitter Power Control (TPC)
Test Site	:	AC-4
Test Mode	:	Mode 1: Transmit by 802.11a – chain 100

Test Conditions		Frequency (MHz)	Measured Power (dBm)	Test Cable Loss (dB)	EIRP of TPC (dBm)	Limit (dBm)
Tnom (25 °C)	Vnom (AC 230V)	5745	10.34	1.3	13.68	24
		5825	10.71	1.3	14.05	24
Tmax (40 °C)	Vmax (AC 253V)	5745	9.26	1.3	12.60	24
		5825	9.53	1.3	12.87	24
Tmax (40 °C)	Vmin (AC 207V)	5745	9.25	1.3	12.59	24
		5825	9.53	1.3	12.87	24
Tmin (0 °C)	Vmax (AC 253V)	5745	11.52	1.3	14.86	24
		5825	11.85	1.3	15.19	24
Tmin (0 °C)	Vmin (AC 207V)	5745	11.53	1.3	14.87	24
		5825	11.85	1.3	15.19	24

EIRP of TPC = Measured Power + Antenna Gain + Test Cable Loss + 10 log (1/Duty Cycle)

Product	:	WIRELESS-N NETWORK MINI PCI ADAPTER
Test Item	:	Transmitter Power Control (TPC)
Test Site	:	AC-4
Test Mode	:	Mode 2: Transmit by 802.11n(20MHz) – chain 100

Test Conditions		Frequency (MHz)	Measured Power (dBm)	Test Cable Loss (dB)	EIRP of TPC (dBm)	Limit (dBm)
Tnom (25 °C)	Vnom (AC 230V)	5745	10.34	1.3	13.68	24
		5825	10.71	1.3	14.05	24
Tmax (40 °C)	Vmax (AC 253V)	5745	9.27	1.3	12.61	24
		5825	9.55	1.3	12.89	24
Tmax (40 °C)	Vmin (AC 207V)	5745	9.26	1.3	12.60	24
		5825	9.54	1.3	12.88	24
Tmin (0 °C)	Vmax (AC 253V)	5745	11.52	1.3	14.86	24
		5825	11.92	1.3	15.26	24
Tmin (0 °C)	Vmin (AC 207V)	5745	11.52	1.3	14.86	24
		5825	11.93	1.3	15.27	24

EIRP of TPC = Measured Power + Antenna Gain + Test Cable Loss + 10 log (1/Duty Cycle)

Product	:	WIRELESS-N NETWORK MINI PCI ADAPTER
Test Item	:	Transmitter Power Control (TPC)
Test Site	:	AC-4
Test Mode	:	Mode 2: Transmit by 802.11n(20MHz) – chain 110

Test Conditions		Frequency (MHz)	Measured Power (dBm)	Test Cable Loss (dB)	EIRP of TPC (dBm)	Limit (dBm)
Tnom (25 °C)	Vnom (AC 230V)	5745	10.51	1.3	13.85	24
		5825	10.76	1.3	14.10	24
Tmax (40 °C)	Vmax (AC 253V)	5745	9.48	1.3	12.82	24
		5825	9.57	1.3	12.91	24
Tmax (40 °C)	Vmin (AC 207V)	5745	9.48	1.3	12.82	24
		5825	9.56	1.3	12.90	24
Tmin (0 °C)	Vmax (AC 253V)	5745	11.72	1.3	15.06	24
		5825	11.94	1.3	15.28	24
Tmin (0 °C)	Vmin (AC 207V)	5745	11.73	1.3	15.07	24
		5825	11.94	1.3	15.28	24

EIRP of TPC = Measured Power + Antenna Gain + Test Cable Loss + 10 log (1/Duty Cycle)

5. Transmitter Unwanted Emissions Outside the 5725 MHz to 5875 MHz Band

5.1. Test Equipment

Transmitter Unwanted Emissions Outside the 5725 MHz to 5875 MHz Band / AC-4

Instrument	Manufacturer	Type No.	Serial No.	Cal. Date
Spectrum Analyzer	Agilent	E4446A	MY45300103	2008/06/11
PSG Analog S.G.	Agilent	E8257D	MY44321116	2008/06/11
Preamplifier	Quietek	AP-025C	QT-AP005	2007/11/25
Preamplifier	Quietek	AP-180C	CHM-0602013	2007/11/25
Bilog Type Antenna	Schaffner	CBL6141A	4278	2007/11/25
Half Wave Tuned Dipole Antenna	COM-POWER	AD-100	40137	2008/06/28
Broad-Band Horn Antenna	Schwarzbeck	BBHA9120D	496	2008/06/28
Broad-Band Horn Antenna	Schwarzbeck	BBHA9170	499	2008/06/28
Broad-Band Horn Antenna	Schwarzbeck	BBHA9170	294	2008/06/28
Broad-Band Horn Antenna	Schwarzbeck	BBHA9120D	295	2008/06/28
High-Pass Filter	Wainwright	WHKX7.0/18G-8SS	SN16	2008/03/03
Low-Pass Filter	Wainwright	WLKS4500-9SS	SN2	2008/03/03
Coaxial Cable	Huber+Suhner	AC4-RL	06	2007/11/25
Coaxial Cable	Huber+Suhner	AC4-RH	07	2007/11/25
Coaxial Cable	Huber+Suhner	AC4-T	08	2007/11/25
Coaxial Cable	Huber+Suhner	AC4-RF	09	2007/11/25
Temperature/Humidity Meter	zhicheng	ZC1-2	QT-TH007	2008/03/09

Note: All equipments are calibrated with traceable calibrations. Each calibration is traceable to the national or international standards.

5.2. Test Setup

For Conducted Measurement

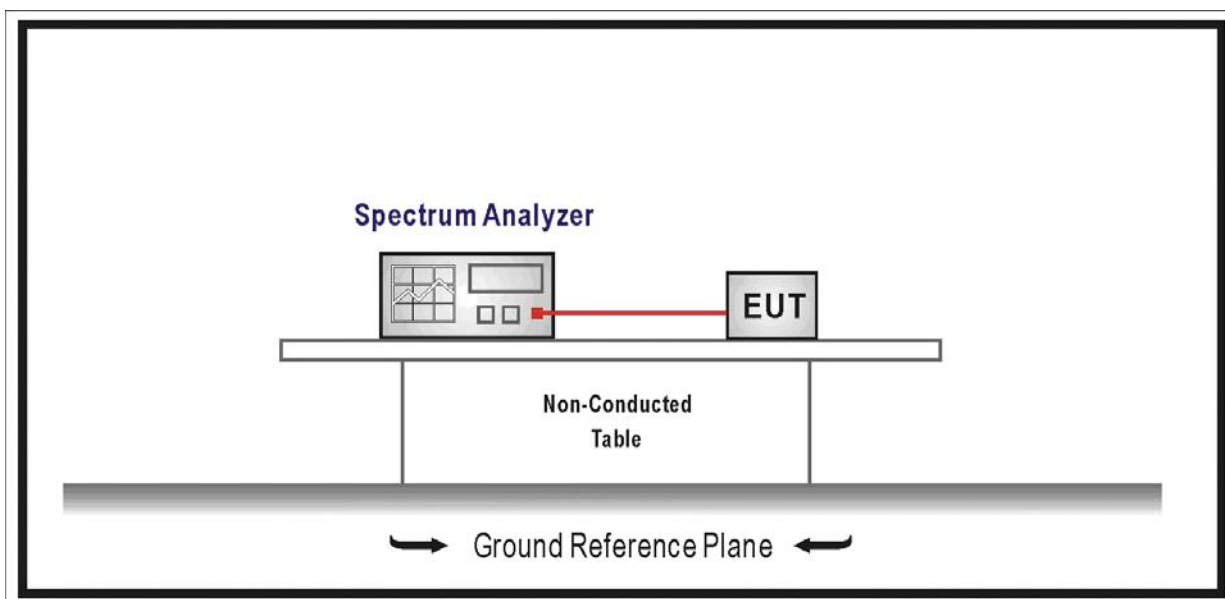

For Radiated Measurement

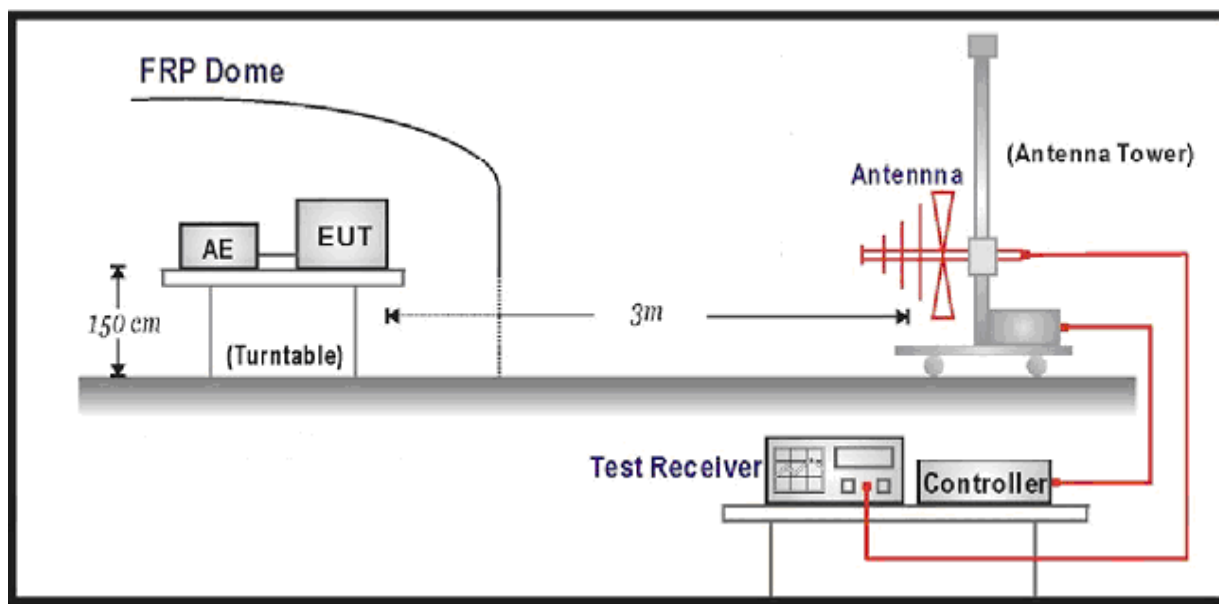

5.3. Limit

Frequency Range (MHz)	Limit (dBm)	Bandwidth (kHz) (see note)
30 to 1000	-36	100
1000 to 5725	-30	1000
5875 to 26500	-30	1000

Note: At frequencies just below 5725 MHz or just above 5875 MHz, account shall be taken of the spacing between the emission centre frequency and the measurement centre frequency to evaluate the appropriate reference bandwidth given in annex 2 of CEPT/ERC Recommendation 74-01 [10].

5.4. Test Procedure

Refer to ETSI EN 302 502 V1.1.1 (2006-11) Clause 5.3.4.1

5.5. Test Result

Mode 1: 802.11a (Chain 100)					
Frequency (MHz)	Polarization (H/V)	Measure Level (dBm)	Limit (dBm)	Margin (dB)	Detector
Channel 149 (5745MHz)					
114.06	H	-53.58	-36	-17.58	PEAK
114.06	V	-55.26	-36	-19.26	PEAK
363.03	H	-57.16	-36	-21.16	PEAK
363.03	V	-52.95	-36	-16.95	PEAK
590.98	H	-58.03	-36	-22.03	PEAK
590.98	V	-50.27	-36	-14.27	PEAK
1498.00	H	-46.57	-30	-16.57	PEAK
1498.00	V	-48.25	-30	-18.25	PEAK
5387.60	H	-52.64	-30	-22.64	PEAK
5387.60	V	-51.17	-30	-21.17	PEAK
11750.50	H	-42.05	-30	-12.05	PEAK
11750.50	V	-44.67	-30	-14.67	PEAK
Channel 165 (5825MHz)					
154.48	H	-49.27	-36	-13.27	PEAK
154.48	V	-53.05	-36	-17.05	PEAK
413.15	H	-50.07	-36	-14.07	PEAK
413.15	V	-49.52	-36	-13.52	PEAK
545.72	H	-51.22	-36	-15.22	PEAK
545.72	V	-55.39	-36	-19.39	PEAK
1643.25	H	-49.38	-30	-19.38	PEAK
1643.25	V	-47.27	-30	-17.27	PEAK
5409.60	H	-53.59	-30	-23.59	PEAK
5409.60	V	-51.29	-30	-21.29	PEAK
12050.60	H	-43.84	-30	-13.84	PEAK
12050.60	V	-48.45	-30	-18.45	PEAK

Mode 1: 802.11n(20MHz) (Chain 100)					
Frequency (MHz)	Polarization (H/V)	Measure Level (dBm)	Limit (dBm)	Margin (dB)	Detector
Channel 149 (5745MHz)					
136.70	H	-57.02	-36	-21.02	PEAK
136.70	V	-52.45	-36	-16.45	PEAK
272.50	H	-47.30	-36	-11.30	PEAK
272.50	V	-49.50	-36	-13.50	PEAK
561.88	H	-52.40	-36	-16.40	PEAK
561.88	V	-55.28	-36	-19.28	PEAK
1989.08	H	-48.08	-30	-18.08	PEAK
1989.08	V	-46.25	-30	-16.25	PEAK
5415.80	H	-51.26	-30	-21.26	PEAK
5415.80	V	-53.07	-30	-23.07	PEAK
11750.50	H	-42.57	-30	-12.57	PEAK
11750.50	V	-44.09	-30	-14.09	PEAK
Channel 165 (5825MHz)					
148.01	H	-59.77	-36	-23.77	PEAK
148.01	V	-58.27	-36	-22.27	PEAK
306.45	H	-56.29	-36	-20.29	PEAK
306.45	V	-49.02	-36	-13.02	PEAK
590.98	H	-52.17	-36	-16.17	PEAK
590.98	V	-50.73	-36	-14.73	PEAK
1664.00	H	-49.50	-30	-19.50	PEAK
1664.00	V	-48.25	-30	-18.25	PEAK
5409.60	H	-51.17	-30	-21.17	PEAK
5409.60	V	-52.39	-30	-22.39	PEAK
12050.60	H	-42.57	-30	-12.57	PEAK
12050.60	V	-43.16	-30	-13.16	PEAK

Mode 1: 802.11a (Chain 010)					
Frequency (MHz)	Polarization (H/V)	Measure Level (dBm)	Limit (dBm)	Margin (dB)	Detector
Channel 149 (5745MHz)					
178.73	H	-56.79	-36	-20.79	PEAK
178.73	V	-53.17	-36	-17.17	PEAK
363.03	H	-50.05	-36	-14.05	PEAK
363.03	V	-49.18	-36	-13.18	PEAK
545.72	H	-52.26	-36	-16.26	PEAK
545.72	V	-55.38	-36	-19.38	PEAK
1332.00	H	-48.50	-30	-18.50	PEAK
1332.00	V	-49.27	-30	-19.27	PEAK
5416.60	H	-51.16	-30	-21.16	PEAK
5416.60	V	-52.27	-30	-22.27	PEAK
11750.50	H	-46.36	-30	-16.36	PEAK
11750.50	V	-42.25	-30	-12.25	PEAK
Channel 165 (5825MHz)					
128.62	H	-55.39	-36	-19.39	PEAK
128.62	V	-56.24	-36	-20.24	PEAK
314.53	H	-52.19	-36	-16.19	PEAK
314.53	V	-57.38	-36	-21.38	PEAK
608.76	H	-56.13	-36	-20.13	PEAK
608.76	V	-58.87	-36	-22.87	PEAK
1643.25	H	-49.95	-30	-19.95	PEAK
1643.25	V	-50.28	-30	-20.28	PEAK
5409.60	H	-53.07	-30	-23.07	PEAK
5409.60	V	-51.17	-30	-21.17	PEAK
12050.60	H	-43.58	-30	-13.58	PEAK
12050.60	V	-45.78	-30	-15.78	PEAK

Mode 1: 802.11n(20MHz) (Chain 010)					
Frequency (MHz)	Polarization (H/V)	Measure Level (dBm)	Limit (dBm)	Margin (dB)	Detector
Channel 149 (5745MHz)					
128.62	H	-60.03	-36	-24.03	PEAK
128.62	V	-57.68	-36	-21.68	PEAK
390.52	H	-49.58	-36	-13.58	PEAK
390.52	V	-52.63	-36	-16.63	PEAK
641.10	H	-60.38	-36	-24.38	PEAK
641.10	V	-54.85	-36	-18.85	PEAK
1664.00	H	-49.37	-30	-19.37	PEAK
1664.00	V	-48.16	-30	-18.16	PEAK
5415.80	H	-51.13	-30	-21.13	PEAK
5415.80	V	-52.29	-30	-22.29	PEAK
11750.50	H	-42.36	-30	-12.36	PEAK
11750.50	V	-43.18	-30	-13.18	PEAK
Channel 165 (5825MHz)					
144.78	H	-57.49	-36	-21.49	PEAK
144.78	V	-55.32	-36	-19.32	PEAK
531.17	H	-59.63	-36	-23.63	PEAK
531.17	V	-53.66	-36	-17.66	PEAK
608.76	H	-60.04	-36	-24.04	PEAK
608.76	V	-58.20	-36	-22.20	PEAK
1498.00	H	-48.39	-30	-18.39	PEAK
1498.00	V	-47.17	-30	-17.17	PEAK
5409.60	H	-51.15	-30	-21.15	PEAK
5409.60	V	-53.05	-30	-23.05	PEAK
12050.60	H	-44.72	-30	-14.72	PEAK
12050.60	V	-42.36	-30	-12.36	PEAK

Mode 1: 802.11n(20MHz) (Chain 110)					
Frequency (MHz)	Polarization (H/V)	Measure Level (dBm)	Limit (dBm)	Margin (dB)	Detector
Channel 149 (5745MHz)					
136.70	H	-57.95	-36	-21.95	PEAK
136.70	V	-55.69	-36	-19.69	PEAK
314.53	H	-50.35	-36	-14.35	PEAK
314.53	V	-53.28	-36	-17.28	PEAK
590.98	H	-55.06	-36	-19.06	PEAK
590.98	V	-57.20	-36	-21.20	PEAK
1332.00	H	-48.57	-30	-18.57	PEAK
1332.00	V	-49.50	-30	-19.50	PEAK
5387.60	H	-53.59	-30	-23.59	PEAK
5387.60	V	-52.16	-30	-22.16	PEAK
11750.50	H	-43.25	-30	-13.25	PEAK
11750.50	V	-42.63	-30	-12.63	PEAK
Channel 165 (5825MHz)					
144.74	H	-56.67	-36	-20.67	PEAK
144.74	V	-57.38	-36	-21.38	PEAK
272.50	H	-55.06	-36	-19.06	PEAK
272.50	V	-57.26	-36	-21.26	PEAK
561.88	H	-54.57	-36	-18.57	PEAK
561.88	V	-59.66	-36	-23.66	PEAK
2058.25	H	-49.06	-30	-19.06	PEAK
2058.25	V	-47.76	-30	-17.76	PEAK
5409.60	H	-50.74	-30	-20.74	PEAK
5409.60	V	-52.23	-30	-22.23	PEAK
12050.60	H	-42.37	-30	-12.37	PEAK
12050.60	V	-42.96	-30	-12.96	PEAK

5.6. Test Photograph

Test Mode: Transmit

Description: Transmitter Spurious Emissions Test Setup for Under 1GHz

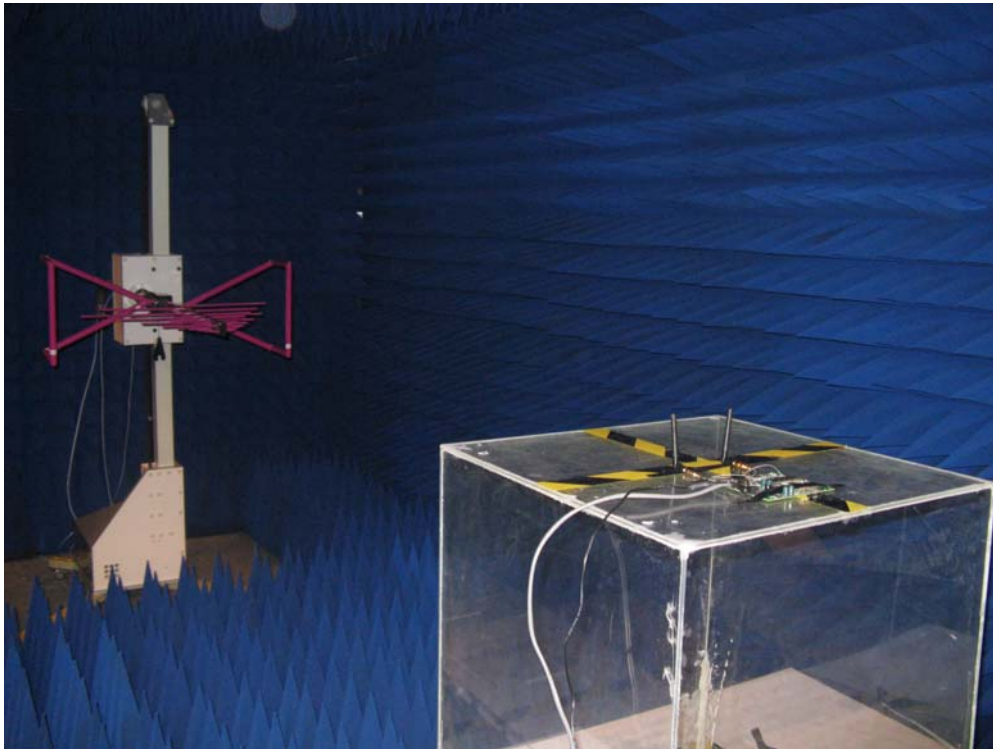

Test Mode: Transmit

Description: Transmitter Spurious Emissions Test Setup for Above 1GHz

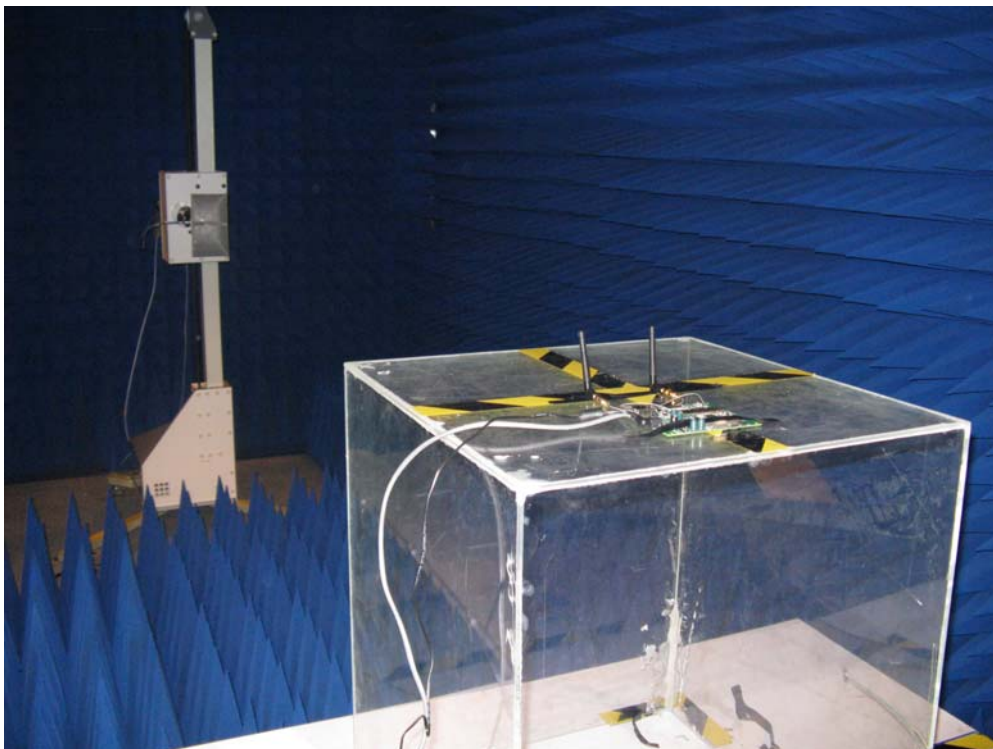

6. Transmitter Unwanted Emissions Within the 5725 MHz to 5875 MHz Band

6.1. Test Equipment

Transmitter Unwanted Emissions Within the 5725 MHz to 5875 MHz Band / AC-4

Instrument	Manufacturer	Type No.	Serial No.	Cal. Date
Spectrum Analyzer	Agilent	E4446A	MY45300103	2008/06/11
Preamplifier	QuieTek	AP-180C	CHM-0602013	2007/11/25
Broad-Band Horn Antenna	Schwarzbeck	BBHA9120D	496	2008/06/28
Coaxial Cable	Huber+Suhner	AC4-RH	07	2007/11/25
Coaxial Cable	Huber+Suhner	AC4-RF	09	2007/11/25
Temperature/Humidity Meter	zhicheng	ZC1-2	QT-TH007	2008/03/09

Note: All equipments are calibrated with traceable calibrations. Each calibration is traceable to the national or international standards.

6.2. Test Setup

For Conducted Measurement

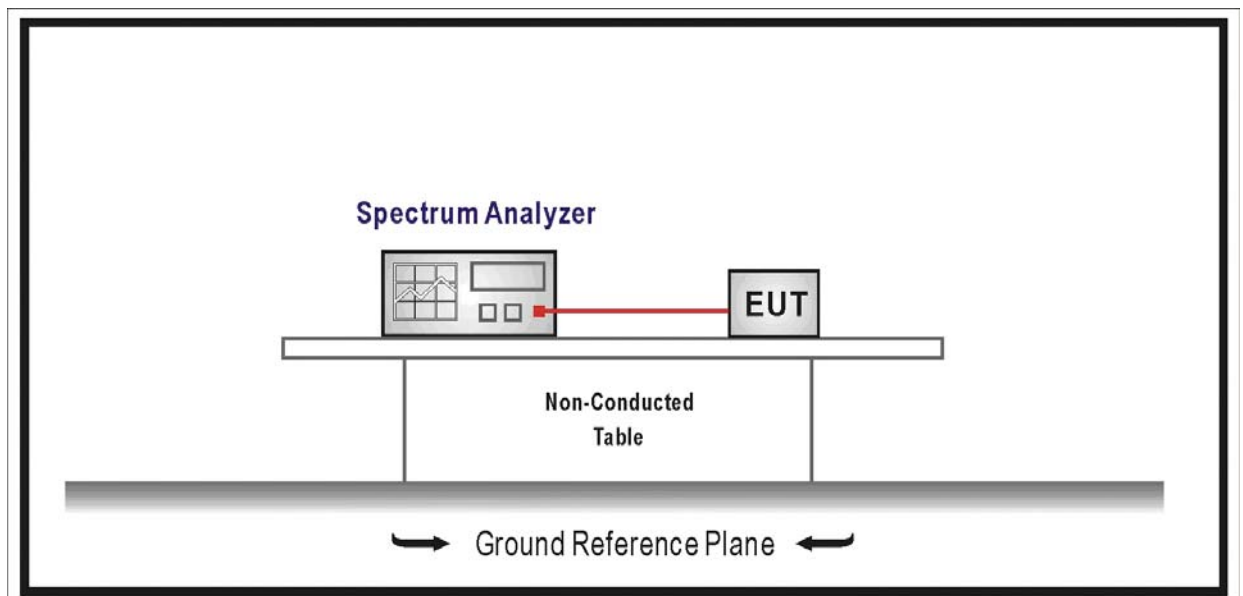

For Radiated Measurement

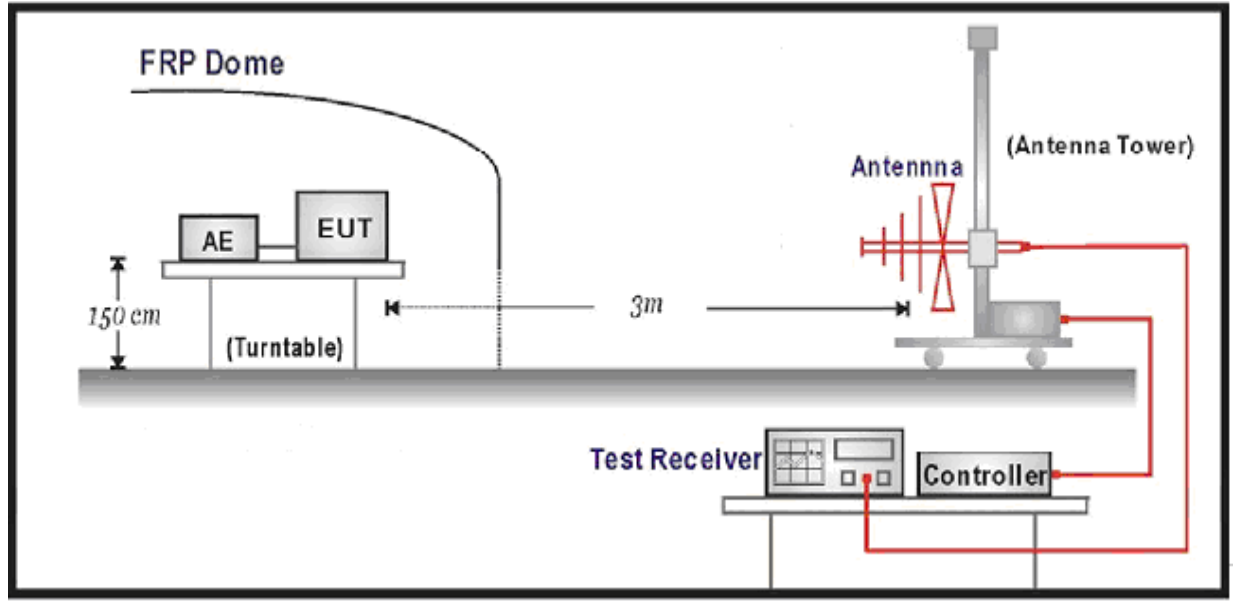

6.3. Limit

The average level of the transmitted spectrum based on the declared ChS shall not exceed the limits given in figure 1 when operating under highest output power conditions.

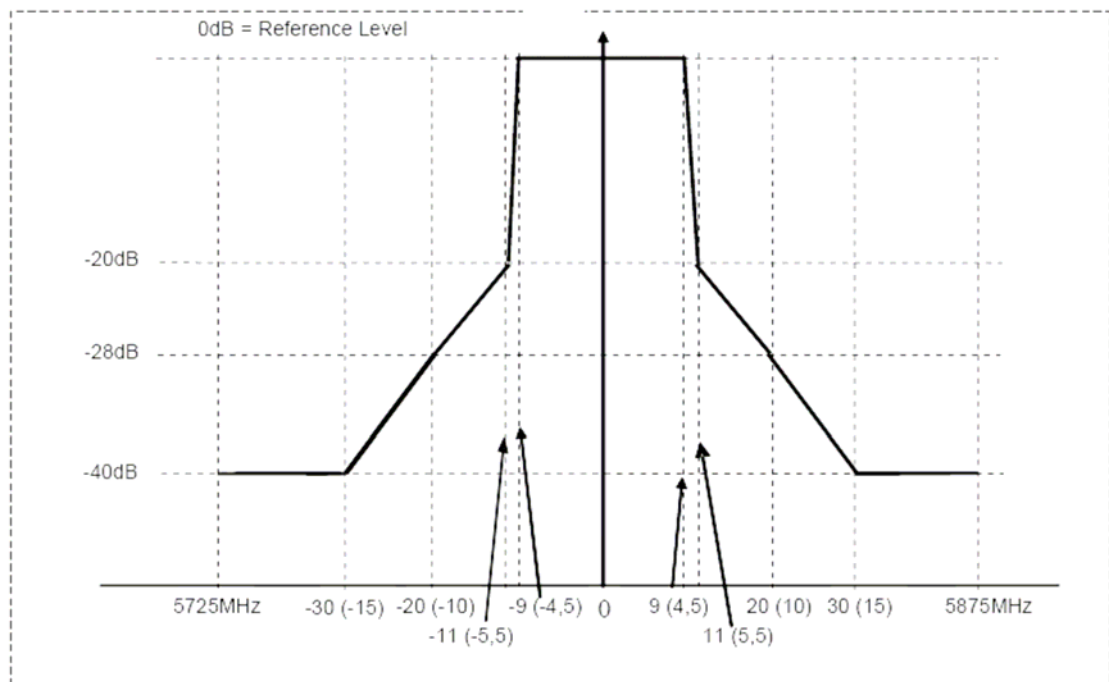

- NOTE 1: 0 dB Reference Level is the spectral density relative to the maximum spectral power density of the transmitted signal.
- NOTE 2: On the Frequency Offset axis, the figures apply to ChS = 20 MHz whereas the figures in parentheses apply to ChS = 10 MHz.
- NOTE 3: Emissions that fall outside the lower and upper band frequency limits of 5 725 MHz and 5 875 MHz respectively shall instead meet the unwanted emission limits of clause 4.3.1.

Figure 1: Emission Mask

6.4. Test Procedure

Refer to ETSI EN 302 502 V1.1.1 (2006-11) Clause 5.3.4.2

6.5. Test Result

Product	:	WIRELESS-N NETWORK MINI PCI ADAPTER
Test Item	:	Transmitter Unwanted Emissions Within the 5725 MHz to 5875 MHz Band
Test Site	:	AC-4
Test Mode	:	Mode 1: Transmit by 802.11a – chain 010

Horizontal

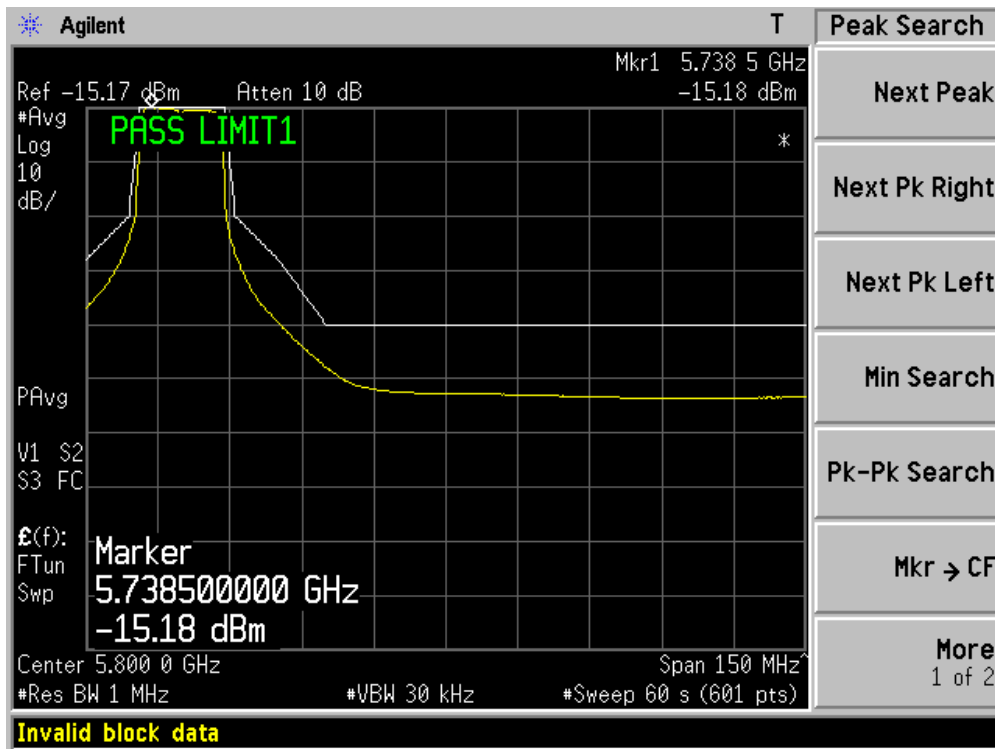

Vertical

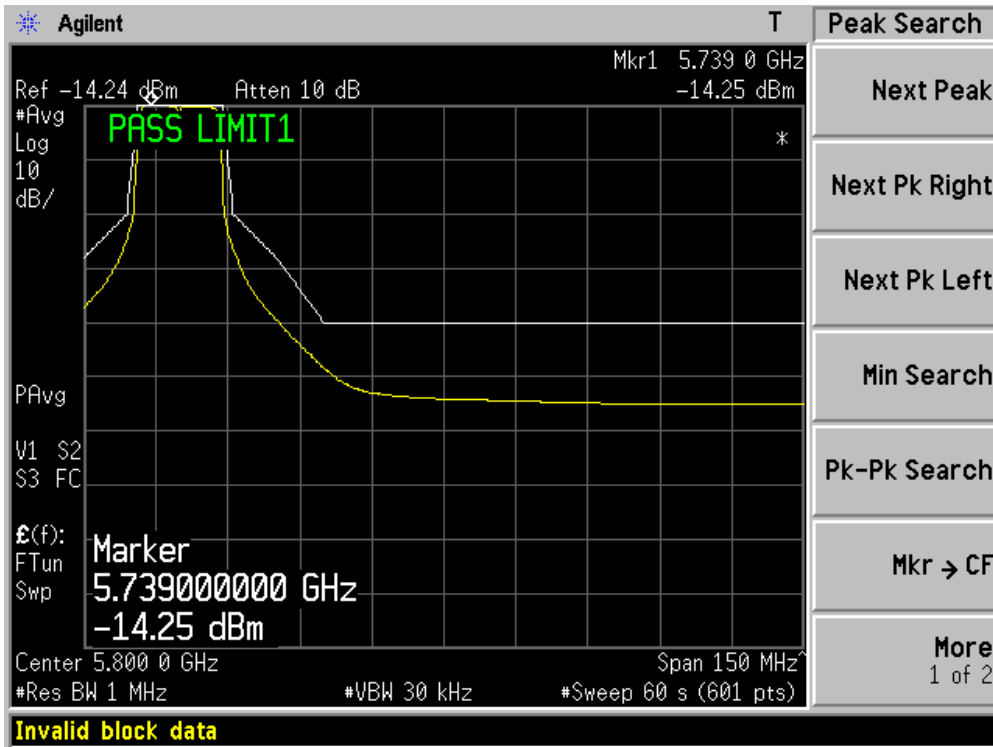

Horizontal

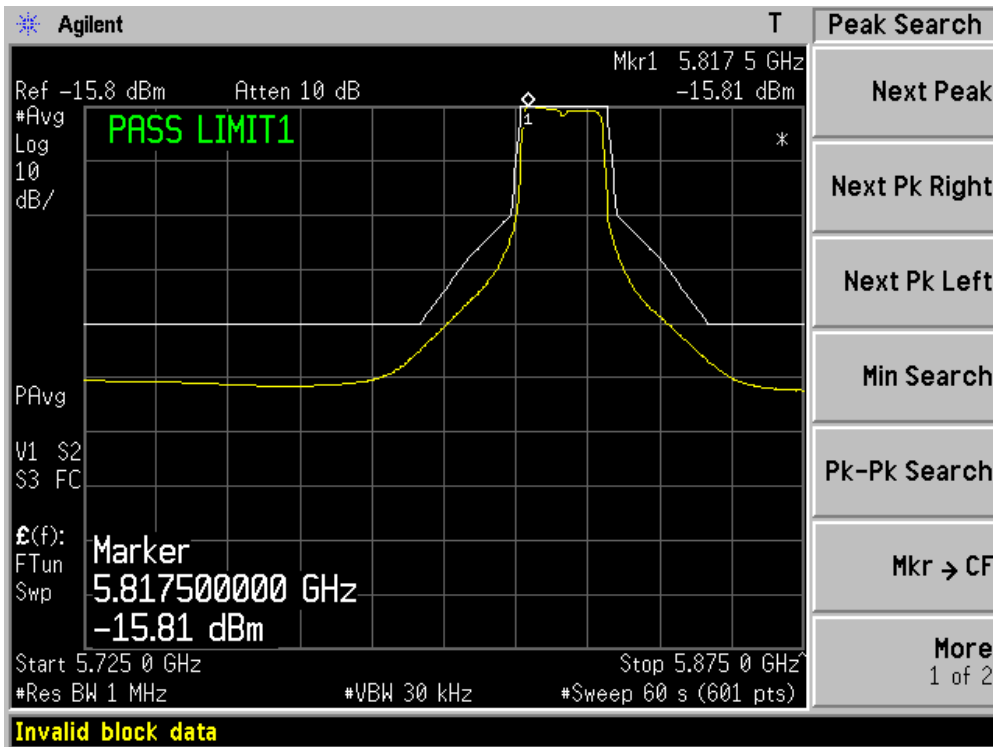

Vertical

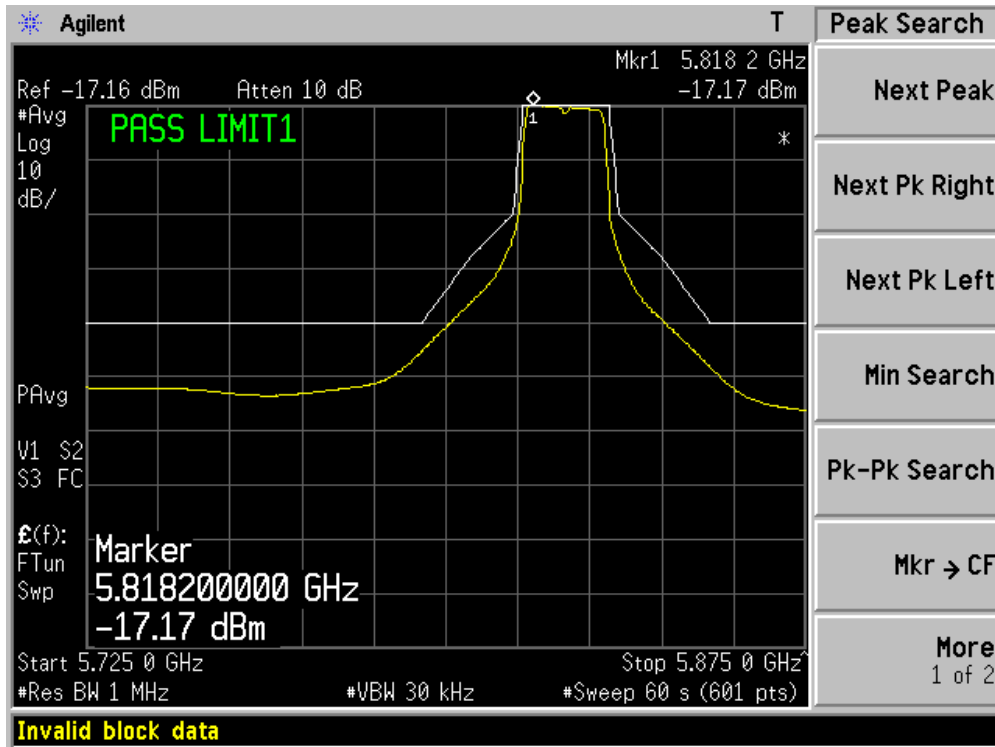

Product	:	WIRELESS-N NETWORK MINI PCI ADAPTER
Test Item	:	Transmitter Unwanted Emissions Within the 5725 MHz to 5875 MHz Band
Test Site	:	AC-4
Test Mode	:	Mode 2: Transmit by 802.11n(20MHz) – chain 010

Horizontal

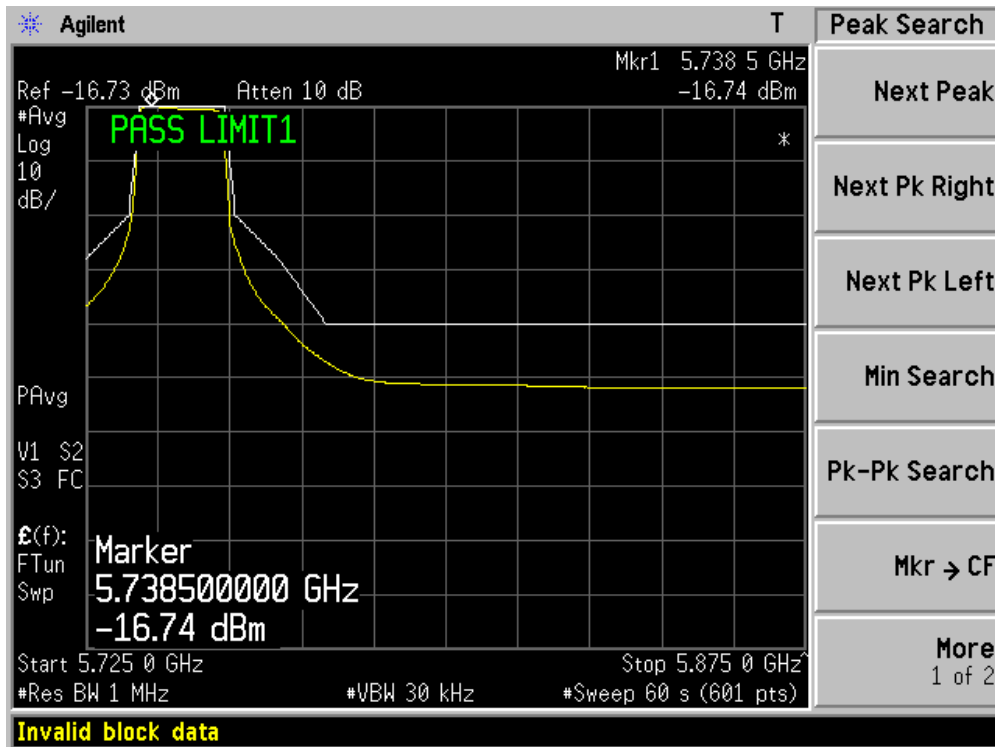

Vertical

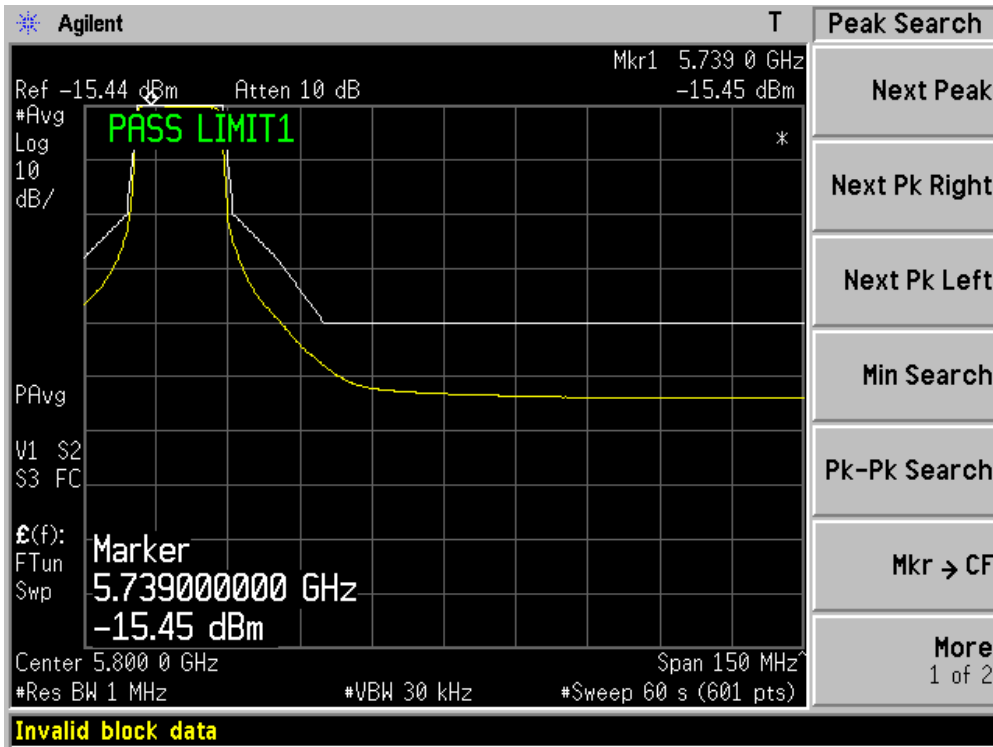

Horizontal

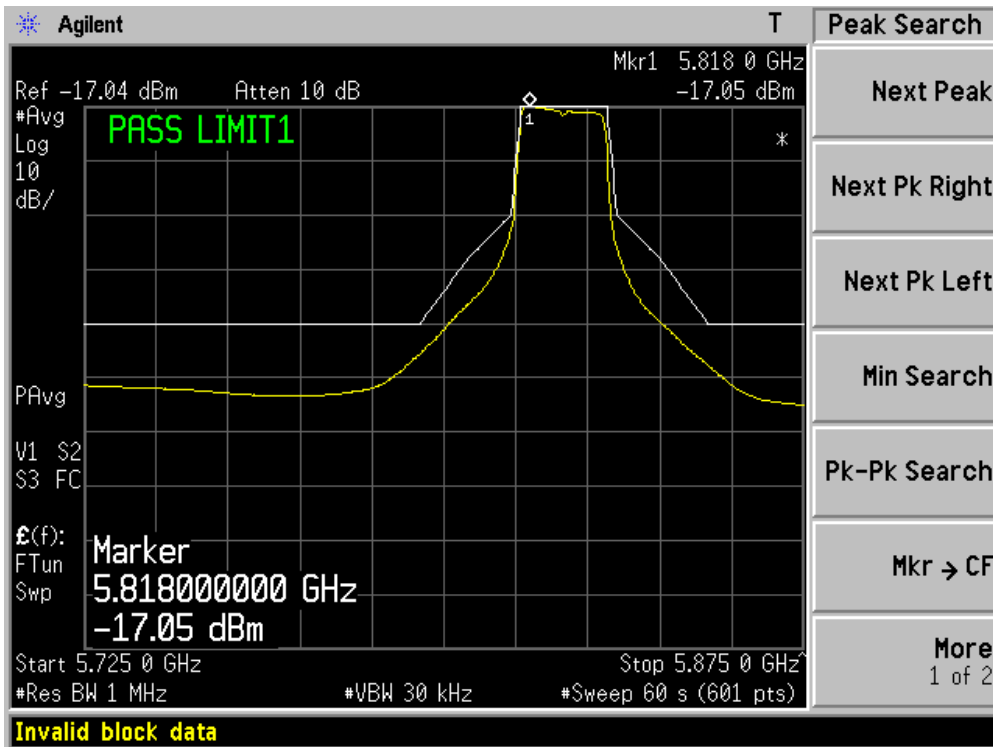

Vertical

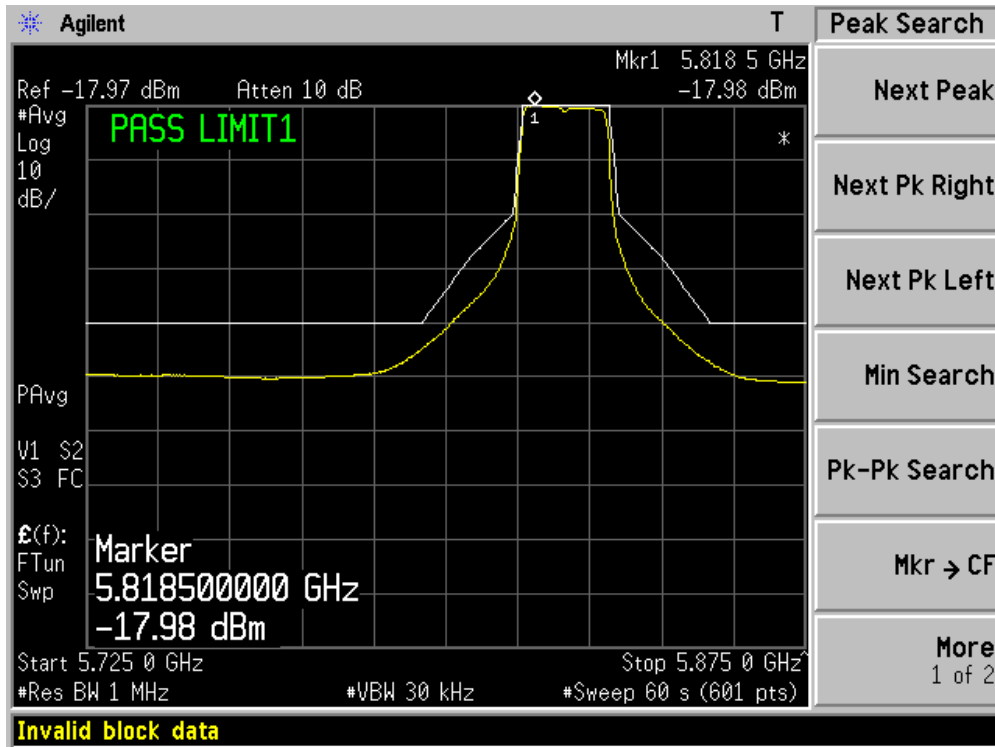

Product	:	WIRELESS-N NETWORK MINI PCI ADAPTER
Test Item	:	Transmitter Unwanted Emissions Within the 5725 MHz to 5875 MHz Band
Test Site	:	AC-4
Test Mode	:	Mode 1: Transmit by 802.11a – chain 100

Horizontal

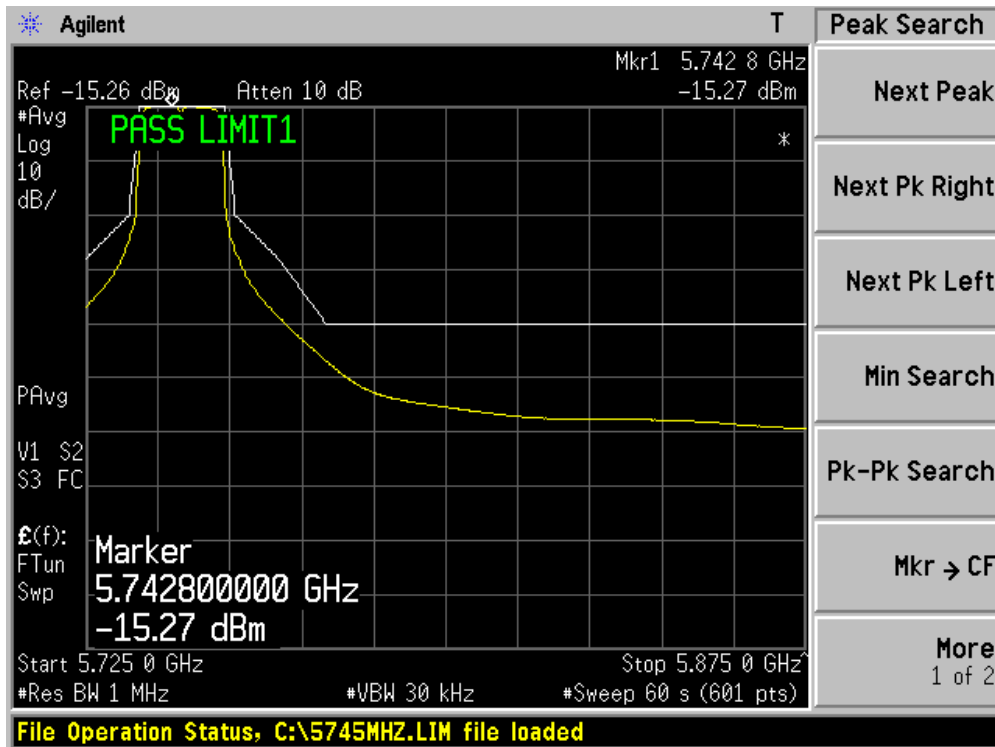

Vertical

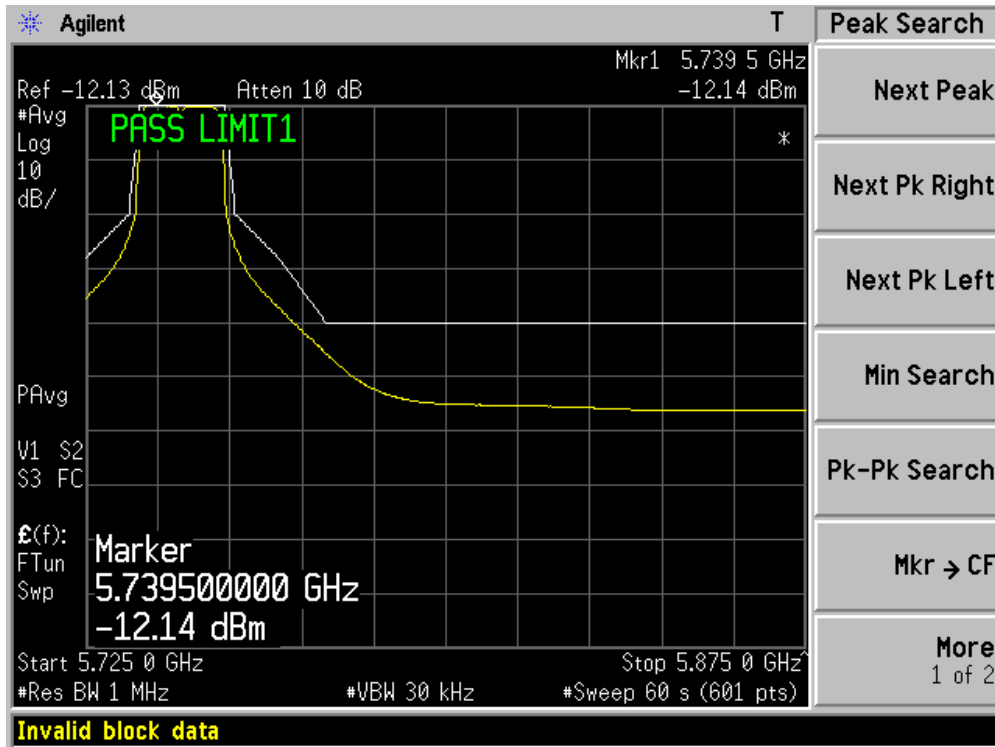

Horizontal

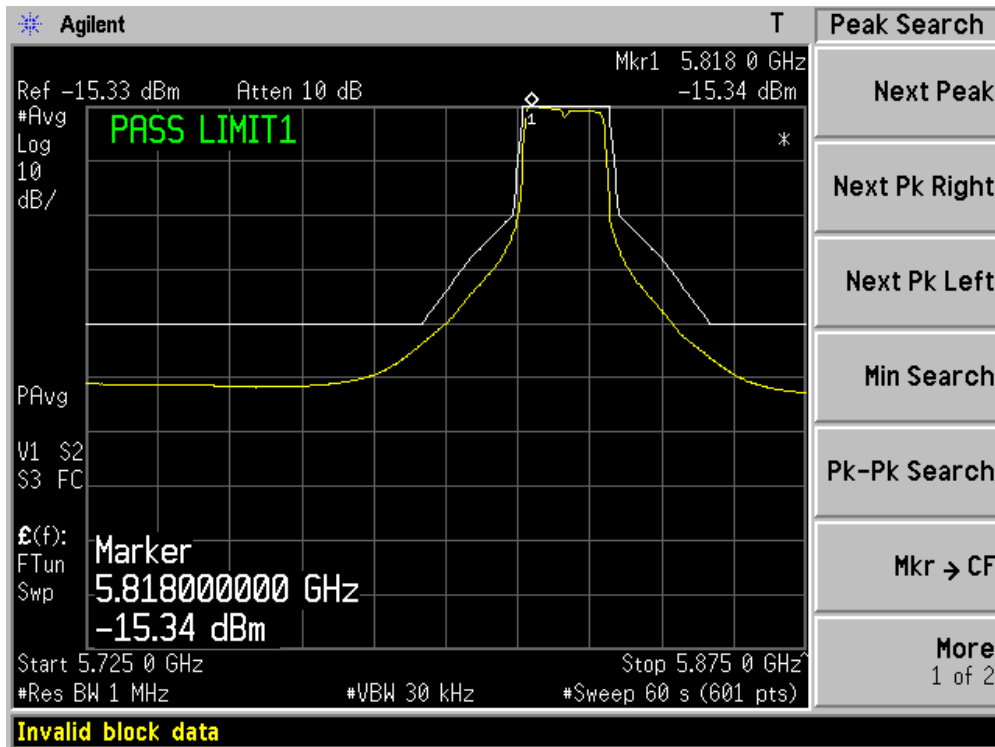

Vertical

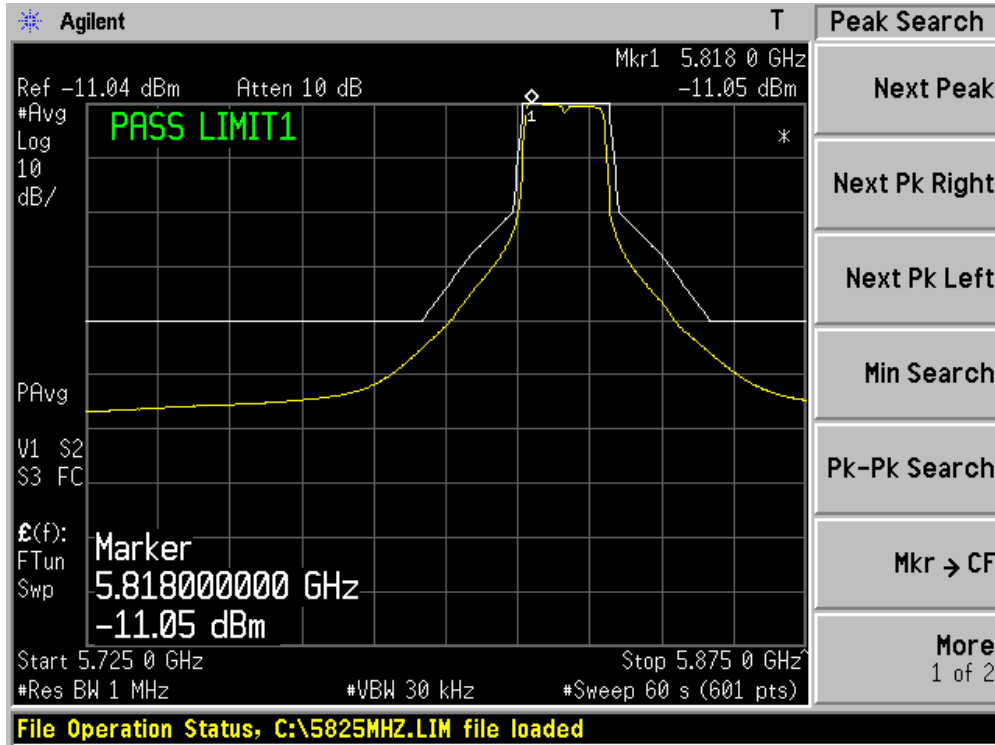

Product	: WIRELESS-N NETWORK MINI PCI ADAPTER
Test Item	: Transmitter Unwanted Emissions Within the 5725 MHz to 5875 MHz Band
Test Site	: AC-4
Test Mode	: Mode 2: Transmit by 802.11n(20MHz) – chain 100

Horizontal

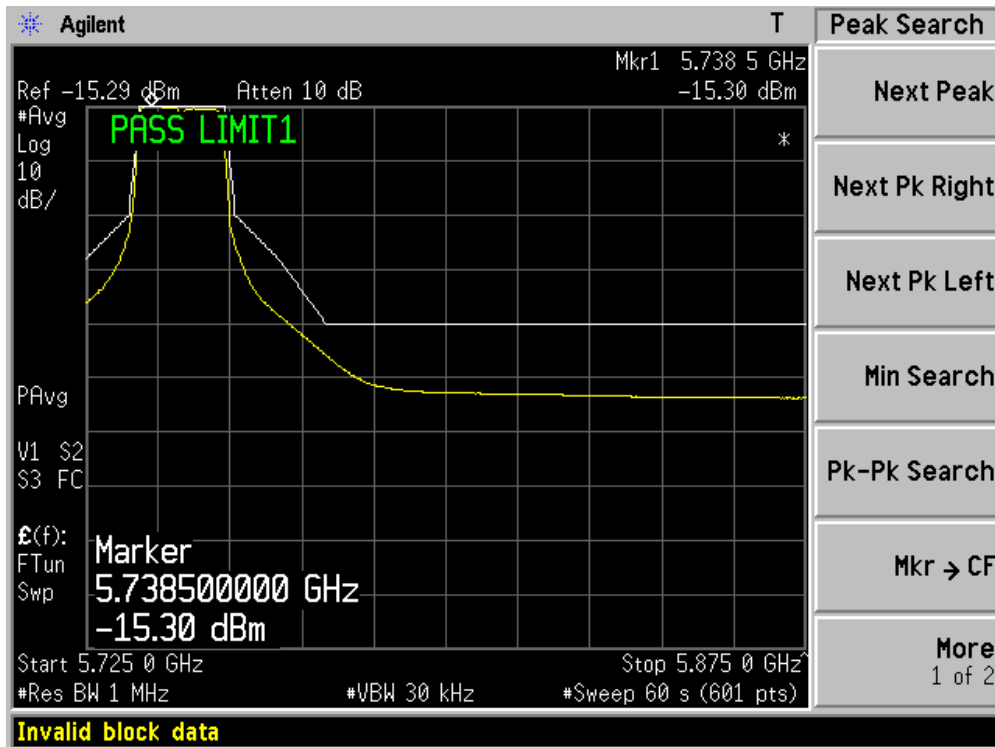

Vertical

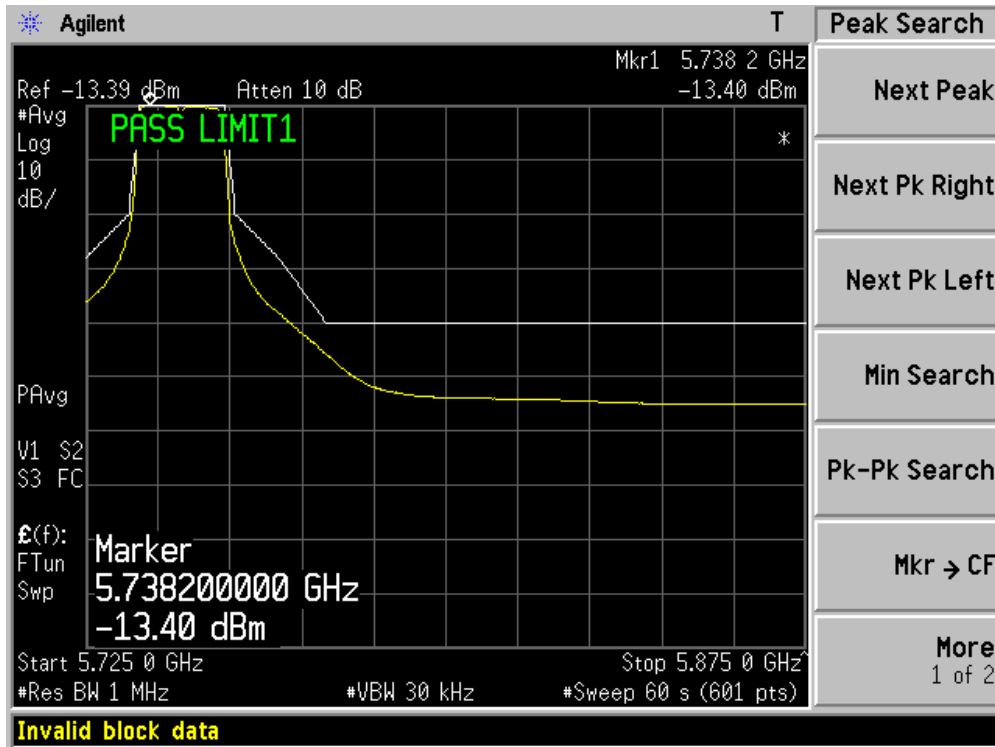

Horizontal

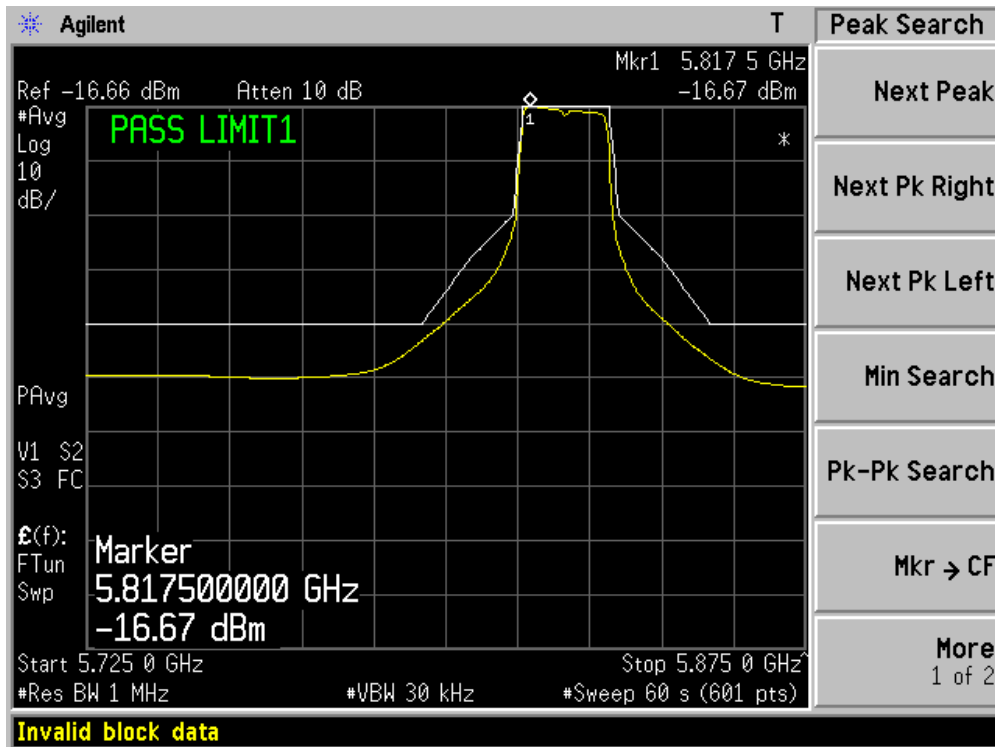

Vertical

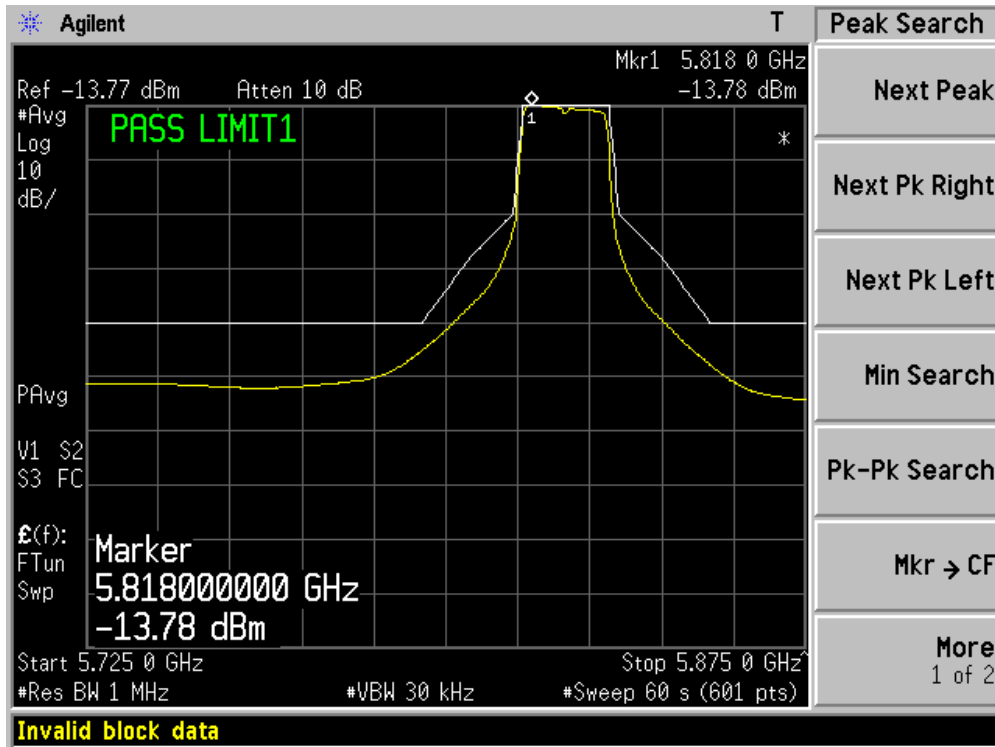

Product	: WIRELESS-N NETWORK MINI PCI ADAPTER
Test Item	: Transmitter Unwanted Emissions Within the 5725 MHz to 5875 MHz Band
Test Site	: AC-4
Test Mode	: Mode 2: Transmit by 802.11n(20MHz) – chain 110

Horizontal

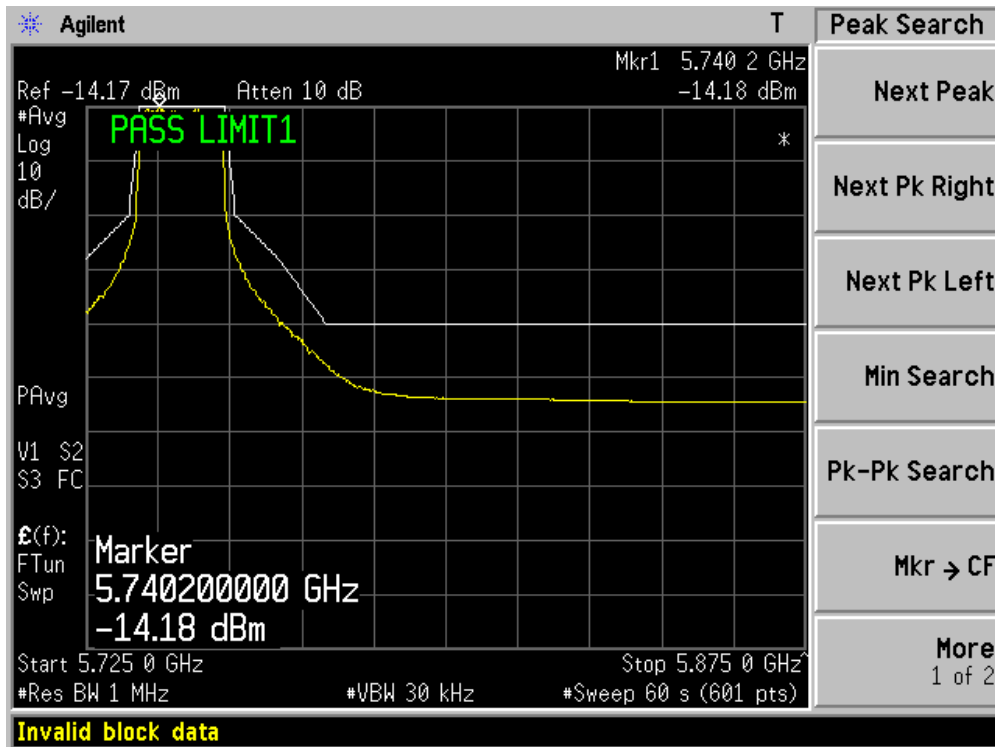

Vertical

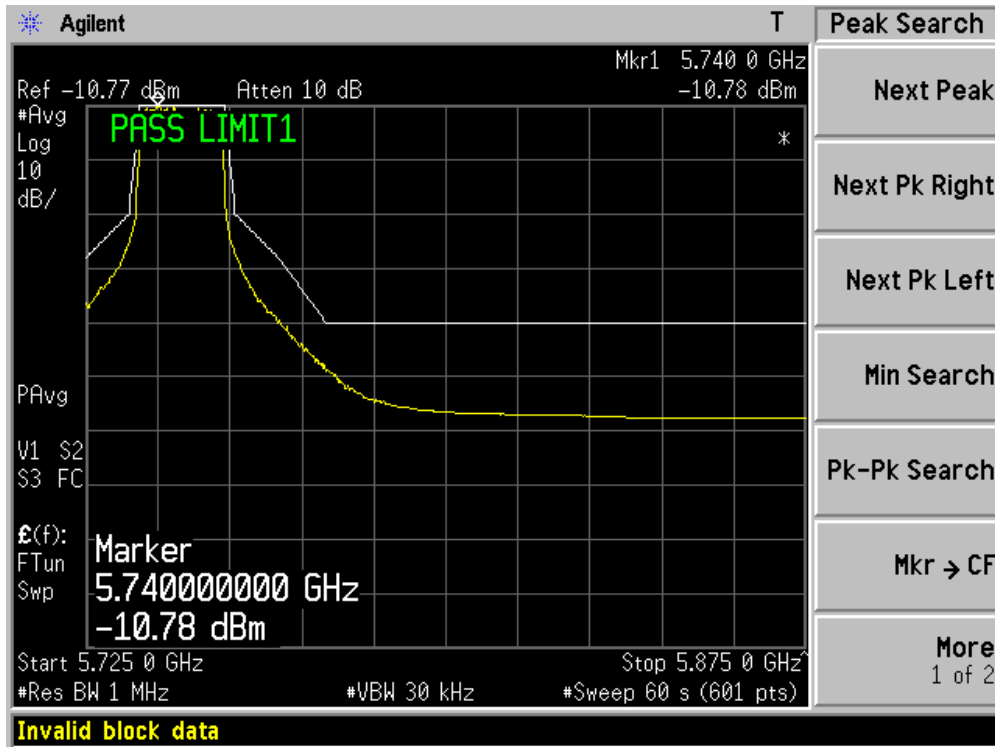

Horizontal

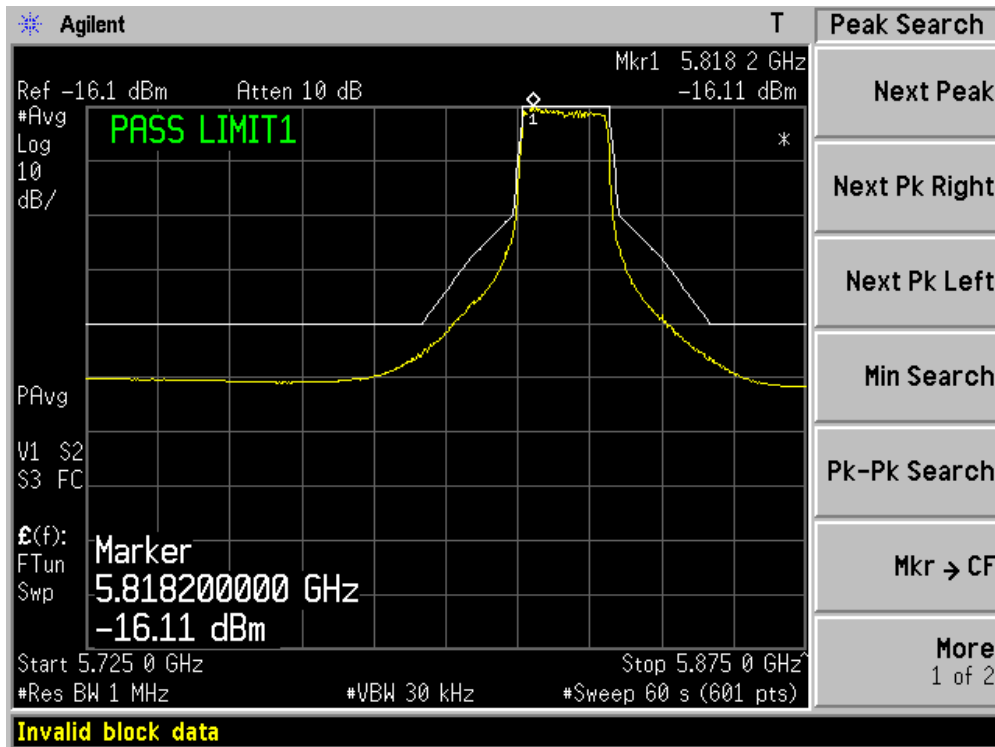

Vertical

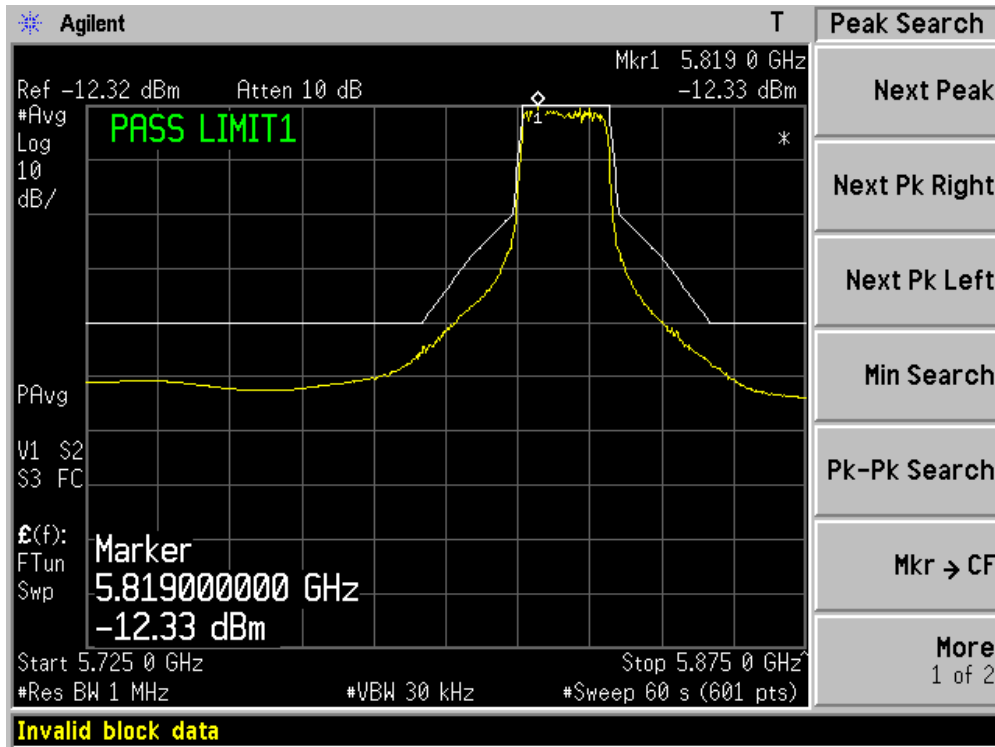

6.6. Test Photograph

Test Mode: Transmit

Description: Transmitter Unwanted Emissions Within the 5GHz RLAN Bands

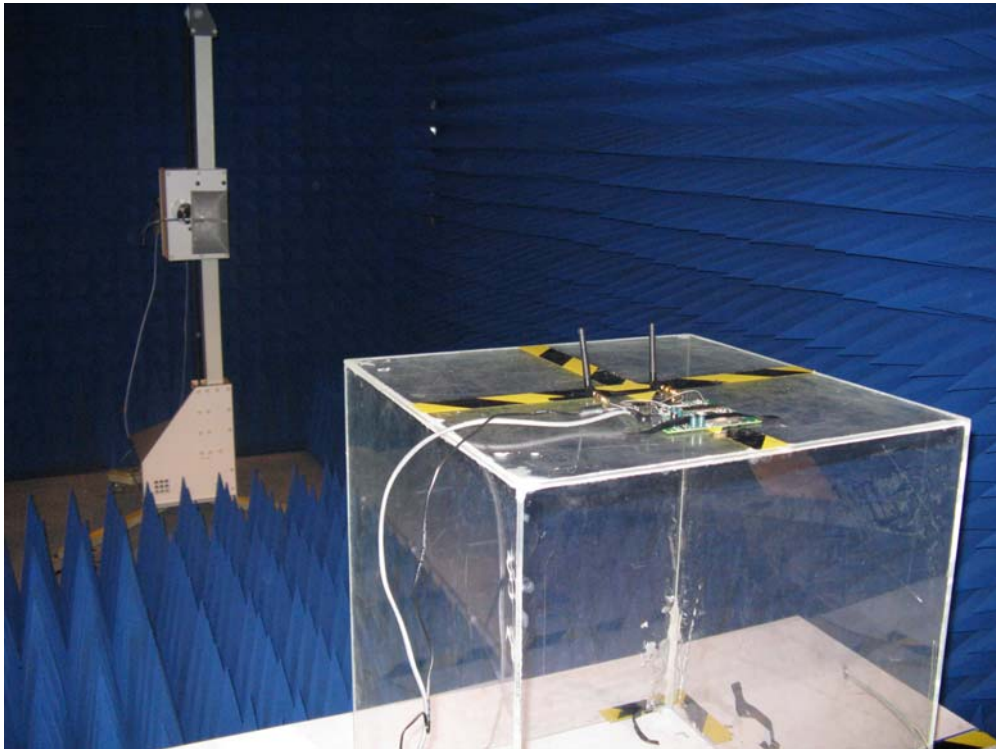

7. Receiver Spurious Emissions

7.1. Test Equipment

Receiver Spurious Emissions / AC-4

Instrument	Manufacturer	Type No.	Serial No.	Cal. Date
Spectrum Analyzer	Agilent	E4446A	MY45300103	2008/06/11
PSG Analog S.G.	Agilent	E8257D	MY44321116	2008/06/11
Preamplifier	Quietek	AP-025C	QT-AP005	2007/11/25
Preamplifier	Quietek	AP-180C	CHM-0602013	2007/11/25
Bilog Type Antenna	Schaffner	CBL6141A	4278	2007/11/25
Half Wave Tuned Dipole Antenna	COM-POWER	AD-100	40137	2007/11/25
Broad-Band Horn Antenna	Schwarzbeck	BBHA9120D	496	2008/06/28
Broad-Band Horn Antenna	Schwarzbeck	BBHA9170	499	2008/06/28
Broad-Band Horn Antenna	Schwarzbeck	BBHA9170	294	2008/06/28
Broad-Band Horn Antenna	Schwarzbeck	BBHA9120D	295	2008/06/28
Coaxial Cable	Huber+Suhner	AC4-RL	06	2007/11/25
Coaxial Cable	Huber+Suhner	AC4-RH	07	2007/11/25
Coaxial Cable	Huber+Suhner	AC4-T	08	2007/11/25
Coaxial Cable	Huber+Suhner	AC4-RF	09	2007/11/25
Temperature/Humidity Meter	zhicheng	ZC1-2	QT-TH007	2008/03/09

Note: All equipments are calibrated with traceable calibrations. Each calibration is traceable to the national or international standards.

7.2. Test Setup

For Conducted Measurement

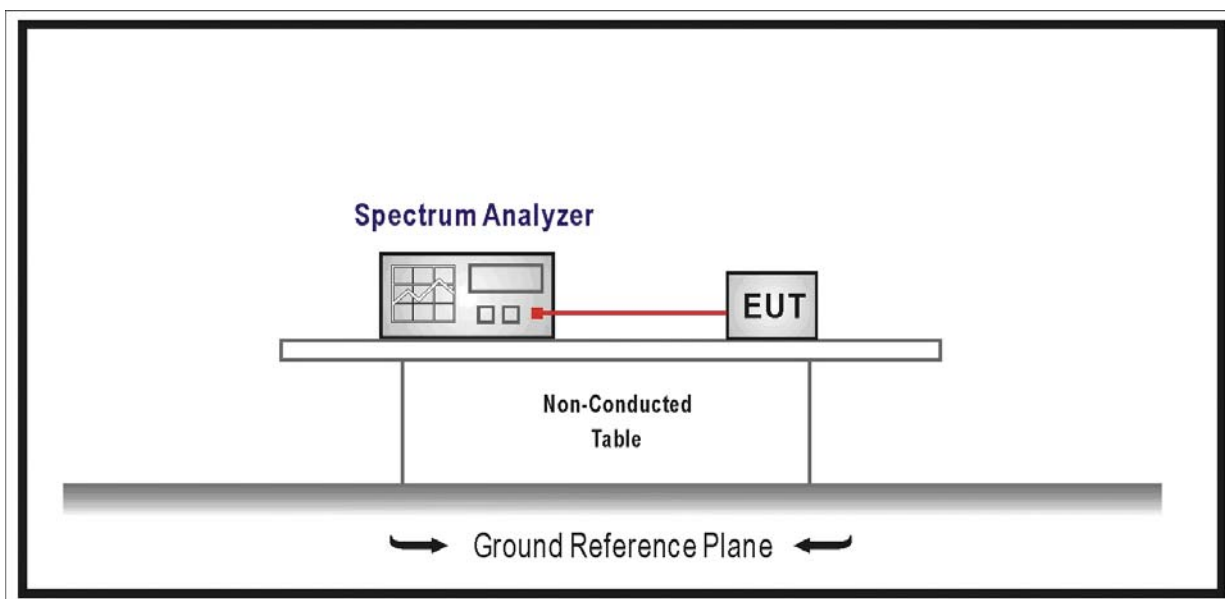

For Radiated Measurement

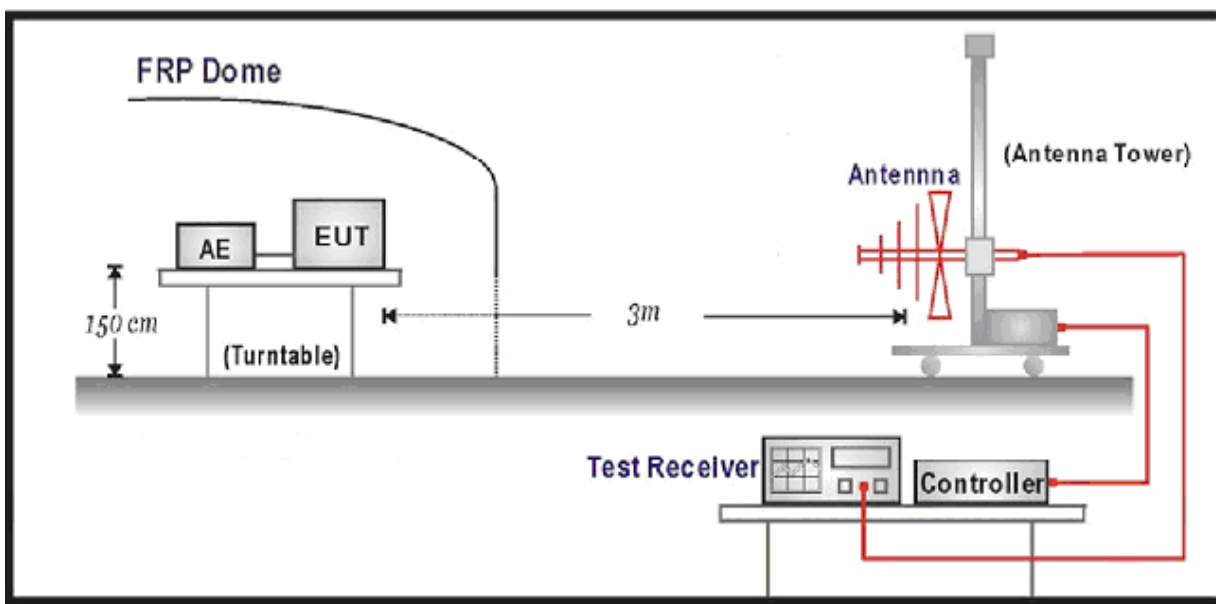

7.3. Limit

Frequency Range	Maximum Power, ERP	Measurement Bandwidth
30 MHz to 1GHz	-57 dBm	100 kHz
1 GHz to 26.5 GHz	-47 dBm	1 MHz

7.4. Test Procedure

Refer to ETSI EN 302 502 V1.1.1 (2006-11) Clause 5.3.5

7.5. Test Result

Mode 1: 802.11n(20MHz) (Chain 100)					
Frequency (MHz)	Polarization (H/V)	Measure Level (dBm)	Limit (dBm)	Margin (dB)	Detector
Channel 149 (5745MHz)					
200.70	H	-65.26	-57	-8.26	PEAK
200.70	V	-63.64	-57	-6.64	PEAK
375.45	H	-64.54	-57	-7.54	PEAK
375.45	V	-63.47	-57	-6.47	PEAK
686.75	H	-70.65	-57	-13.65	PEAK
686.75	V	-67.59	-57	-10.59	PEAK
2138.03	H	-57.05	-47	-10.05	PEAK
2138.03	V	-55.15	-47	-8.15	PEAK
3467.85	H	-53.29	-47	-6.29	PEAK
3467.85	V	-56.27	-47	-9.27	PEAK
3894.46	H	-55.86	-47	-8.86	PEAK
3894.46	V	-53.65	-47	-6.65	PEAK
Channel 165 (5825MHz)					
215.45	H	-67.26	-57	-10.26	PEAK
215.45	V	-65.63	-57	-8.63	PEAK
347.26	H	-65.10	-57	-8.10	PEAK
347.26	V	-66.22	-57	-9.22	PEAK
745.80	H	-64.27	-57	-7.27	PEAK
745.80	V	-63.84	-57	-6.84	PEAK
2057.15	H	-64.85	-47	-17.85	PEAK
2057.15	V	-57.47	-47	-10.47	PEAK
3552.42	H	-56.89	-47	-9.89	PEAK
3552.42	V	-55.36	-47	-8.36	PEAK
4035.55	H	-54.19	-47	-7.19	PEAK
4035.55	V	-53.07	-47	-6.07	PEAK

Mode 1: 802.11n(20MHz) (Chain 010)					
Frequency (MHz)	Polarization (H/V)	Measure Level (dBm)	Limit (dBm)	Margin (dB)	Detector
Channel 149 (5745MHz)					
213.28	H	-65.27	-57	-8.27	PEAK
213.28	V	-64.35	-57	-7.35	PEAK
376.86	H	-67.75	-57	-10.75	PEAK
376.86	V	-65.44	-57	-8.44	PEAK
707.35	H	-69.78	-57	-12.78	PEAK
707.35	V	-65.06	-57	-8.06	PEAK
2126.30	H	-56.26	-47	-9.26	PEAK
2126.30	V	-55.15	-47	-8.15	PEAK
3015.45	H	-57.10	-47	-10.10	PEAK
3015.45	V	-56.08	-47	-9.08	PEAK
3957.05	H	-53.05	-47	-6.05	PEAK
3957.05	V	-52.12	-47	-5.12	PEAK
Channel 165 (5825MHz)					
307.40	H	-64.38	-57	-7.38	PEAK
307.40	V	-65.28	-57	-8.28	PEAK
592.25	H	-66.49	-57	-9.49	PEAK
592.25	V	-64.97	-57	-7.97	PEAK
814.64	H	-63.30	-57	-6.30	PEAK
814.64	V	-66.12	-57	-9.12	PEAK
1976.26	H	-63.42	-47	-16.42	PEAK
1976.26	V	-59.58	-47	-12.58	PEAK
2592.25	H	-55.48	-47	-8.48	PEAK
2592.25	V	-54.07	-47	-7.07	PEAK
3834.75	H	-53.51	-47	-6.51	PEAK
3834.75	V	-55.26	-47	-8.26	PEAK

Mode 1: 802.11n(20MHz) (Chain 110)					
Frequency (MHz)	Polarization (H/V)	Measure Level (dBm)	Limit (dBm)	Margin (dB)	Detector
Channel 149 (5745MHz)					
215.42	H	-64.25	-57	-7.25	PEAK
215.42	V	-61.64	-57	-4.64	PEAK
358.28	H	-65.36	-57	-8.36	PEAK
358.28	V	-64.47	-57	-7.47	PEAK
652.39	H	-66.93	-57	-9.93	PEAK
652.39	V	-65.07	-57	-8.07	PEAK
2275.15	H	-63.13	-47	-16.13	PEAK
2275.15	V	-55.25	-47	-8.25	PEAK
3085.45	H	-57.55	-47	-10.55	PEAK
3085.45	V	-56.75	-47	-9.75	PEAK
3742.51	H	-54.48	-47	-7.48	PEAK
3742.51	V	-53.14	-47	-6.14	PEAK
Channel 165 (5825MHz)					
309.25	H	-65.26	-57	-8.26	PEAK
309.25	V	-64.96	-57	-7.96	PEAK
570.53	H	-66.06	-57	-9.06	PEAK
570.53	V	-63.36	-57	-6.36	PEAK
786.35	H	-70.14	-57	-13.14	PEAK
786.35	V	-63.38	-57	-6.38	PEAK
2197.75	H	-65.90	-47	-18.90	PEAK
2197.75	V	-57.55	-47	-10.55	PEAK
2853.05	H	-55.37	-47	-8.37	PEAK
2853.05	V	-54.19	-47	-7.19	PEAK
3962.15	H	-56.14	-47	-9.14	PEAK
3962.15	V	-53.84	-47	-6.84	PEAK

7.6. Test Photograph

Test Mode: Receive

Description: Receiver Spurious Emissions Test Setup for Under 1GHz

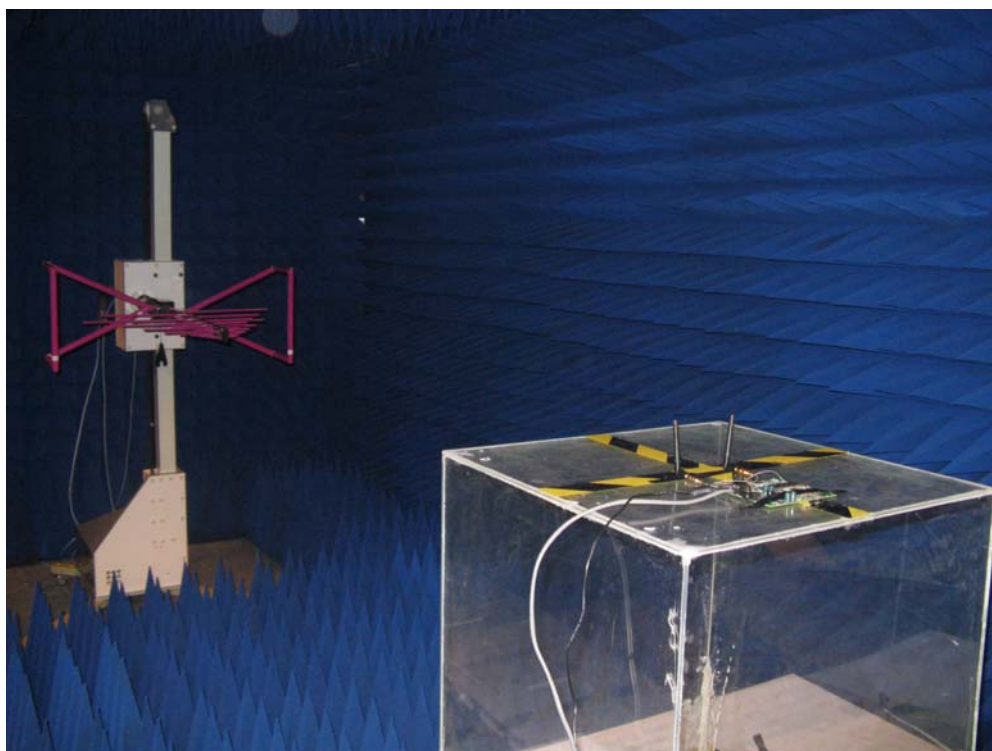

Test Mode: Receive

Description: Receiver Spurious Emissions Test Setup for Above 1GHz

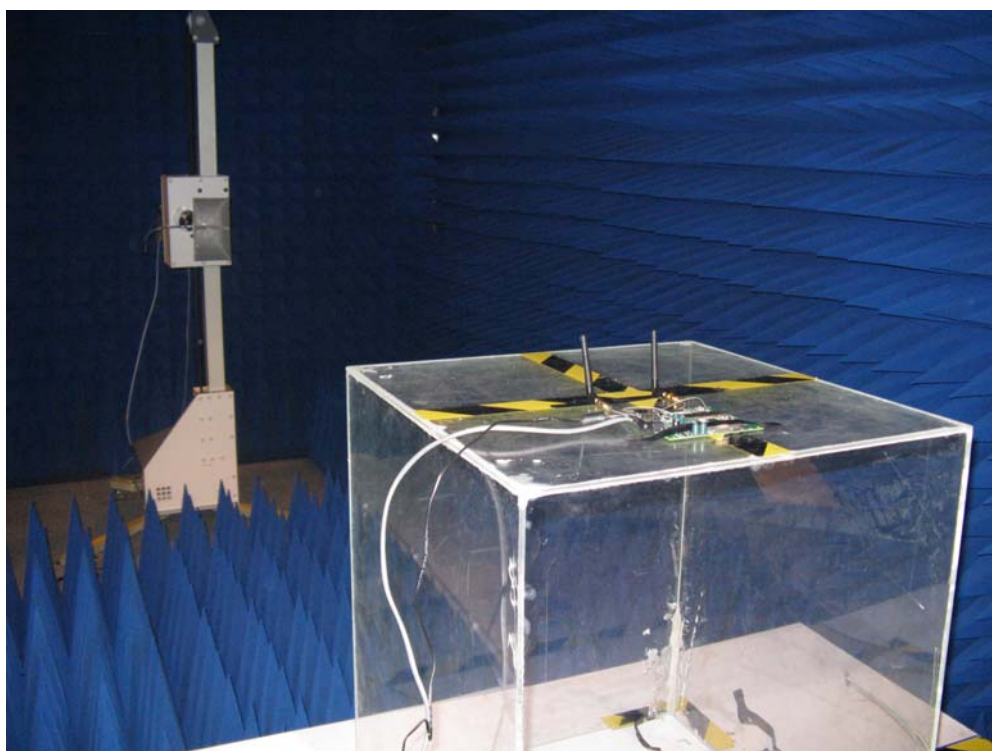

8. Dynamic Frequency Selection (DFS)

8.1. Test Equipment

Dynamic Frequency Selection (DFS) / AC-4

Instrument	Manufacturer	Type No.	Serial No.	Cal. Date
Spectrum Analyzer	Rohde & Schwarz	FSP7	100561	2007/09/03
Vector Signal Generator	Rohde & Schwarz	SUM 200A	102168	2008/01/23
Splitter/Combiner (Qty: 2)	Mini-Circuits	ZAPD-50W 4.2-6.0 GHz	NN256400424	2008/05/18
ATT (Qty: 2)	Mini-Circuits	BW-S3W2 DC-18GHz	0025	2008/05/18
Aironet Lightweight Access Point	Cisco System	1242AG	FOC10352PCV	2007/08/15
RF Cable (Qty: 5)	Schaffner	N/A	25494/6	2008/05/18

Note: All equipments are calibrated with traceable calibrations. Each calibration is traceable to the national or international standards.

8.2. Test Setup

For the purposes of the test, the UUT as well as other devices used in the set-up may be equipped with a specific user interface to allow monitoring of the behaviour of the different devices of the set-up during the tests.

The UUT is capable of transmitting a test transmission sequence as described in clause 5.1.2.2. The signal generator is capable of generating any of the radar test signals defined in tables D.3.1 and D.3.2 of standard.

Adequate measurement equipment, e.g. spectrum analyser, shall be used to measure the aggregate transmission time of the UUT.

Radar test signals are injected into the UUT. The set-up also contains a device which is associated with the UUT.

Following Figure shows an example test set-up.

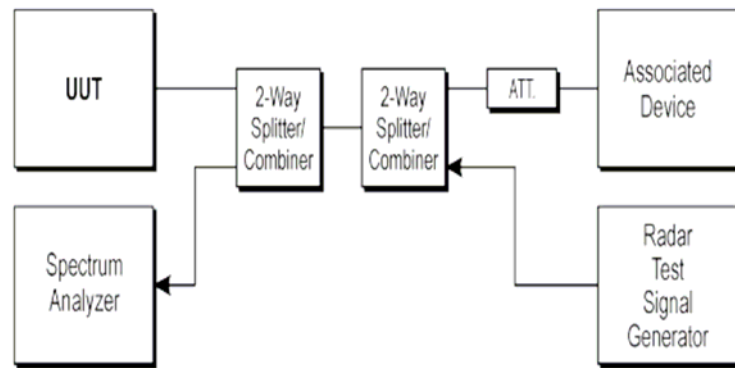

NOTE: UUT can be any type of FWA Device under test. An Associated Device is the equipment required for the UUT to establish a communication link.

Figure 3: Test Set-up

8.3. Limit

Channel availability check and channel revalidation period

The *Channel Availability Check* shall be performed during a continuous period in time (*Channel Availability Check Time*) which shall not be less than the value defined in table D.1. of standard.

During the *Channel Availability Check*, the device shall be capable of detecting any of the radar signals that fall within the range given by tables D.3.1 and D.3.2 of standard with a level above the *Interference Detection Threshold* defined in table D.2. of standard.

The detection probability for a given radar signal shall be greater than the value defined in tables D.3.1 and D.3.2 of standard.

The Channel Revalidation Period for Available Channels remains valid for a maximum period as defined in table D.1 of standard.

In-Service Monitoring

The *In-Service Monitoring* shall be used to continuously monitor an Operating Channel.

The *In-Service Monitoring* shall start immediately after the device has started transmissions on an *Operating Channel*.

During the *In-Service Monitoring*, the RLAN shall be capable of detecting any of the radar signals that fall within the range given by table D.3.1 and D3.2 of standard with a level above the *Interference Detection Threshold* defined in tables D.2 of standard.

The detection probability for a given radar signal shall be greater than the value defined in table D.3.1 and D.3.2 of standard.

Channel Shutdown

The *Channel Shutdown* process shall start immediately after a radar signal has been detected.

The *Channel Move Time* shall not exceed the limit defined in table D.1 of standard.
 The *Channel Closing Transmission Time* shall not exceed the limit defined in table D.1 of standard.

Non-Occupancy Period

The *Non-Occupancy Period* shall not be less than the value defined in table D.1 of standard.

Table D.1: DFS requirement values

Parameter	Value
Channel Availability Check Time	60 s
Channel Move Time	10 s
Channel Closing Transmission Time	260 ms
Non-Occupancy Period	30 min
Channel Revalidation Period	24 hrs

Table D.2: Interference Threshold values

Spectral Density dBm/MHz	Value (see notes 1 and 2)
23	-69 dBm
NOTE 1: This is the level at the input of the receiver assuming a 0 dBi receive antenna. NOTE 2: For FWA devices employing lower EIRP spectral density and a receive antenna gain G (dBi) the threshold follows the following relationships: DFS Detection Threshold (dBm) = -69 + 23 -EIRP Spectral Density (dBm/MHz) + G (dBi). See table D.4 for example calculations.	

8.4. Test Procedure

Refer to ETSI EN 302 502 V1.1.1 (2006-11) Clause 5.3.6

8.5. Test Result

This test result was based on Quietek report **XXXX**

9. Attachment

➤ EUT Photograph

(1) EUT Photo



(2) EUT Photo



(3) EUT Photo

